The V-Dipole LPDA

L. B. Cebik, W4RNL

“The use of V-elements in the antenna of the invention, rather than dipoles, increases the directivity of the invention and also permits more effective utilization of a given antenna since the same structure can be used in several frequency modes to achieve coverage of different frequency bands.”

Paul E. Mayes and Robert L. Carrel¹

Taken out of the context of the complete explanation offered by the patent holders for the V-LPDA, the opening statement has engendered at least two misunderstandings about the antenna, at least in amateur radio literature.

1. Sweeping elements forward in any array—Yagi, log-cell Yagi, or LPDA—increases the gain and the directivity of the array relative to the use of the same elements as straight dipoles.
2. Given any LPDA design for a certain frequency coverage, we may extend the upper limits of continuous coverage by using V-dipoles instead of straight dipoles.

In *LPDA Notes*, I examined the first of these claims (in volume 1, chapter 6, and in volume 2, chapter 4). However, the second claim requires some analysis if we are to understand better the content of the small extract from the Mayes-Carrel patent document. Of course, our goal will be ultimately to better understand the operation of LPDAs that employ V-dipoles instead of their straight counterparts.

We shall divide the present set of notes into three sections. The first will take a reasonably thorough look at a sample published amateur V-LPDA design. Shortcomings in the design will lead us back to the simple V-dipole itself to see the difference between the operation of the element in its fundamental mode and in one of its higher order modes ($3/2\lambda$). Finally, we shall design a usable model of a V-LPDA that is capable of covering two distinct portions of the frequency spectrum. In the process, we shall provide the opening statement with a more fitting context that will put to rest the traditional misunderstandings.

The K4EWG Log-Periodic V Array

In his article, “The Log-Periodic V Array” (*QST*, Oct, 1979, pp. 40-43), Peter D. Rhodes, K4EWG brought attention to the basic concepts underlying the V-LPDA and provided a sample design for which he claimed 7 dBd gain between 7 and 14 MHz and 10 dBd gain on 21 and 28 MHz. His own trial version of the antenna used 5 elements, essentially cut for coverage between 7 and 14 MHz. Ostensibly, the array would cover the higher bands using a higher-order mode of operation. The dimensions for the array appear in the original *QST* article and on page 344 of the 1995 edition of *Rothammels Antennenbuch*.

Our first task is to understand how the design process for V-LPDAs is like and differs from the comparable design process for standard LPDAs that use straight dipole elements. **Fig. 1** overlays the same array with both types of elements to help us in our sorting. Immediately apparent is the fact that we make use of the same design parameters, τ and σ , to determine the length and the spacing of the elements. We need not pause here on this well-published procedure.

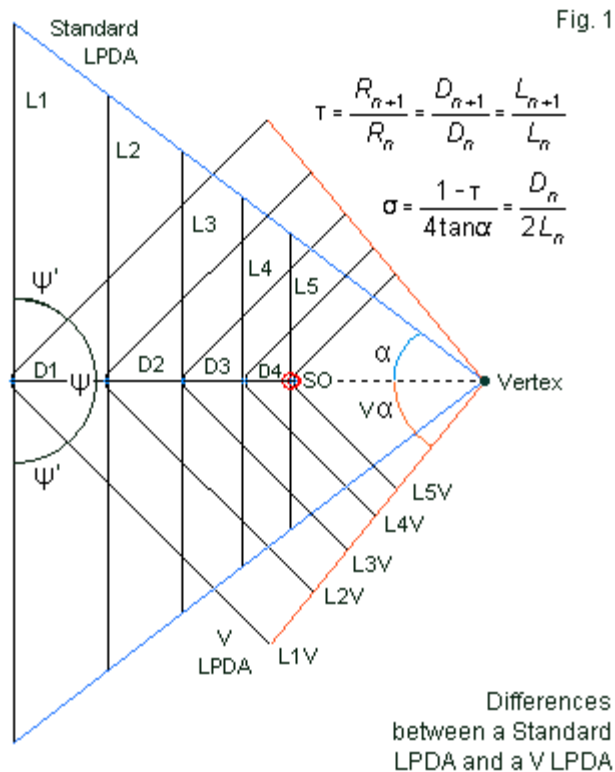

The amount by which we sweep the elements forward to form Vs is subject to 2 methods of designation. Mayes and Carrel use the included angle, ψ , in their work, while Rhodes uses the degree of sweep forward from a straight dipole line, ψ' in the sketch. The relationship between ψ and ψ' is easy to capture: $\psi = 180 - (2 \psi')$ and $\psi' = 0.5 (180 - \psi)$. In the Rhodes prototype, the value of ψ' is 45° , yielding a ψ of 90° . As Mayes and Carrel note, each higher-order mode of operation has a small optimal range of ψ -values. 90° falls within the general range of values applicable to operating an LPDA in the $3/2\text{-}\lambda$ mode at the upper end of its intended range.

The apex angle is a bit more complex. There are conventional LPDA design relationships among τ , σ , and α that define for the process an apex angle that is half the total apex angle formed by the outline of the elements in their straight form. Mayes and Carrel use the total apex angle formed by the V-dipoles (twice the values of $V\alpha$ in the sketch) in some literature. For very long LPDAs using high values of τ , the difference between α and $V\alpha$ is very small and we may generally ignore it. However, in the K4EWG design, the difference is significant. With a τ of 0.8 and a σ of 0.065 (in contrast to the published value of 0.05), the LPDA design value for α is 37.6° (for a total apex angle of 75.2°), while the V-outline apex angle, $V\alpha$ is 50° (for a total apex angle of 100°). As Rhodes notes, his prototype is a somewhat minimalist version with a value of τ (0.8) at the lowest end of values recommended for use in LPDAs. The low value of σ (0.065) follows recommendations for V-LPDAs that employ higher order modes of operation, although Rhodes never specifies the significance of this recommendation.

Modeling a V-LPDA in NEC requires some special attention to the structure. We may model a standard LPDA using 1 wire for each element. If we assign each element an odd number of segments, the phase lines that we create from NEC transmission lines can follow the centerline of the array from one element to the next. V-elements require a 3-wire treatment, with a short center section to accept the phase-line junctions. As shown in **Fig. 2**, the center section must

be long enough so that its segments are roughly the same lengths as the segments in the swept portions of the element, but short enough not to disturb the essential V-shape. An added constraint is the element diameter. Thin wire elements provide the modeler with maximum flexibility, while fat elements limit the number of segments one may use in the center section. Rhodes uses 1.5"-diameter elements in his prototype.

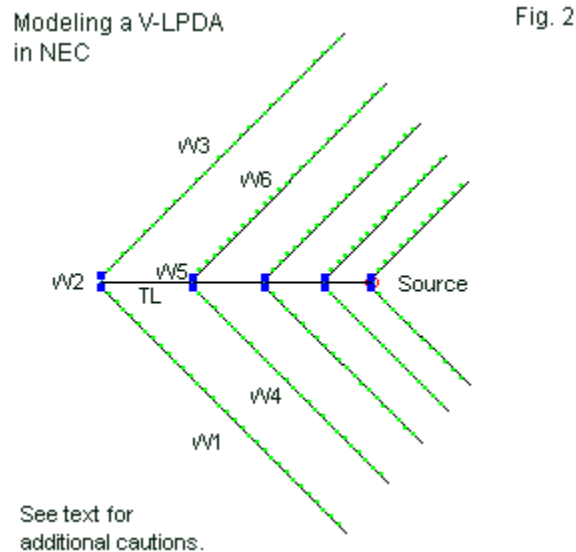

One of the dangers of using very low values of τ is ending up with an LPDA (of any type) that fails to produce the anticipated performance. The goal of the K4EWG prototype was to produce usable performance on the amateur bands between 40 and 10 meters. As well, the antenna was to illustrate the use of higher-order performance in the $3/2\text{-}\lambda$ mode. The array achieves the second of these goals, as illustrated in **Fig. 3** by the current magnitude distribution curves on the elements at 28.5 MHz. The middle element shows the three current peaks that mark $3/2\text{-}\lambda$ operation. Unfortunately, we may note significant current on every element, each with a different mode of operation.

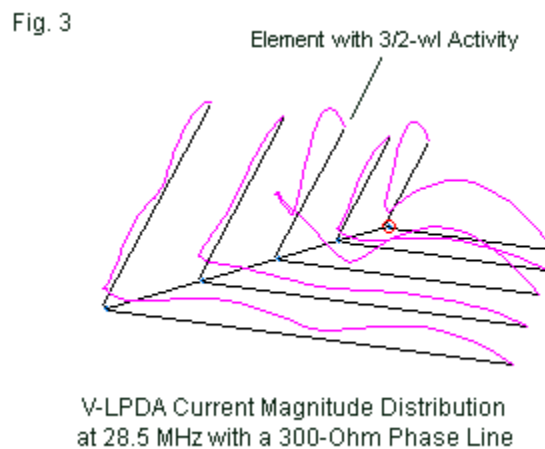

When we model the K4EWG array in free space, we encounter one final modeling problem. Rhodes does not clearly specify the characteristic impedance of his phase line. Photographs

show two AWG #12 wires with fairly wide spacing. Therefore, I modeled the array using three different values for the phase line: 100, 300, and 600 Ω . **Table 1** shows the results of this modeling at the center of each amateur band between 40 and 10 meters

Table 1. Performance of the K4EWG V-Dipole LPDA on amateur bands from 40 to 10 meters using various phase-line characteristic impedance values

Frequency MHz	Gain dBi	Front-back Ratio dB	Impedance R +/- jX Ω
600- Ω Phase Line			
7.15	2.14	1.70	279 + j173
10.125	3.27	3.98	149 - j252
14.175	3.80	8.56	95 - j129
18.118	2.52	3.34	26 + j79
21.225	3.36	6.93	61 + j206
24.95	2.86	1.41	104 + j258
28.5	6.84	7.45	876 + j1152
300- Ω Phase Line			
7.15	2.23	1.89	81 - j3
10.125	3.39	4.11	267 + j120
14.175	3.15	6.36	147 - j99
18.118	3.46	5.04	22 + j77
21.225	4.44	6.31	82 + j163
24.95	5.49	5.14	158 + j27
28.5	6.44	4.82	248 + j431
100- Ω Phase Line			
7.15	2.26	1.94	54 - j23
10.125	3.47	4.10	29 + j38
14.175	3.13	6.14	137 + j57
18.118	4.28	6.27	21 + j78
21.225	5.32	4.67	113 + j57
24.95	6.78	7.05	26 - j50
28.5	6.08	3.58	21 + j70

For comparison, a horizontal dipole in free space has a gain of about 2.15 dBi, while a 2-element driver-reflector Yagi will show about 6 dBi. The Yagi front-to-back ratio will be between 10 and 12 dB—a modest but quite usable figure. The K4EWG array front-to-back values are disappointingly low. The gain nowhere matches the initial claims. However, it does show an interesting progression. At the highest frequencies, the average forward gain is over twice the value of the forward gain at the lowest frequencies.

To demonstrate some of the array's weaknesses, **Fig. 4** provides a gallery of the changing shape of the free-space E-plane patterns as we increase the operating frequency. Because the low value of τ allows the rearward elements to be active at every frequency, we find very considerable energy to the array's rear. On some frequencies, the total rearward energy—taking into account both rearward quadrants—is greater than the forward energy. The net result is that the minimal array fails to give us a clear picture of the performance we might expect from a well-designed V-LPDA. For example, it is not clear from the prototype whether the array achieves continuous coverage or whether it yields coverage in a lower frequency region and again at a higher frequency region. The feedpoint impedance values, especially with higher-impedance phase-line values, tend to show a drop in the resistive component of the impedance near the middle of the operating range (18-21 MHz).

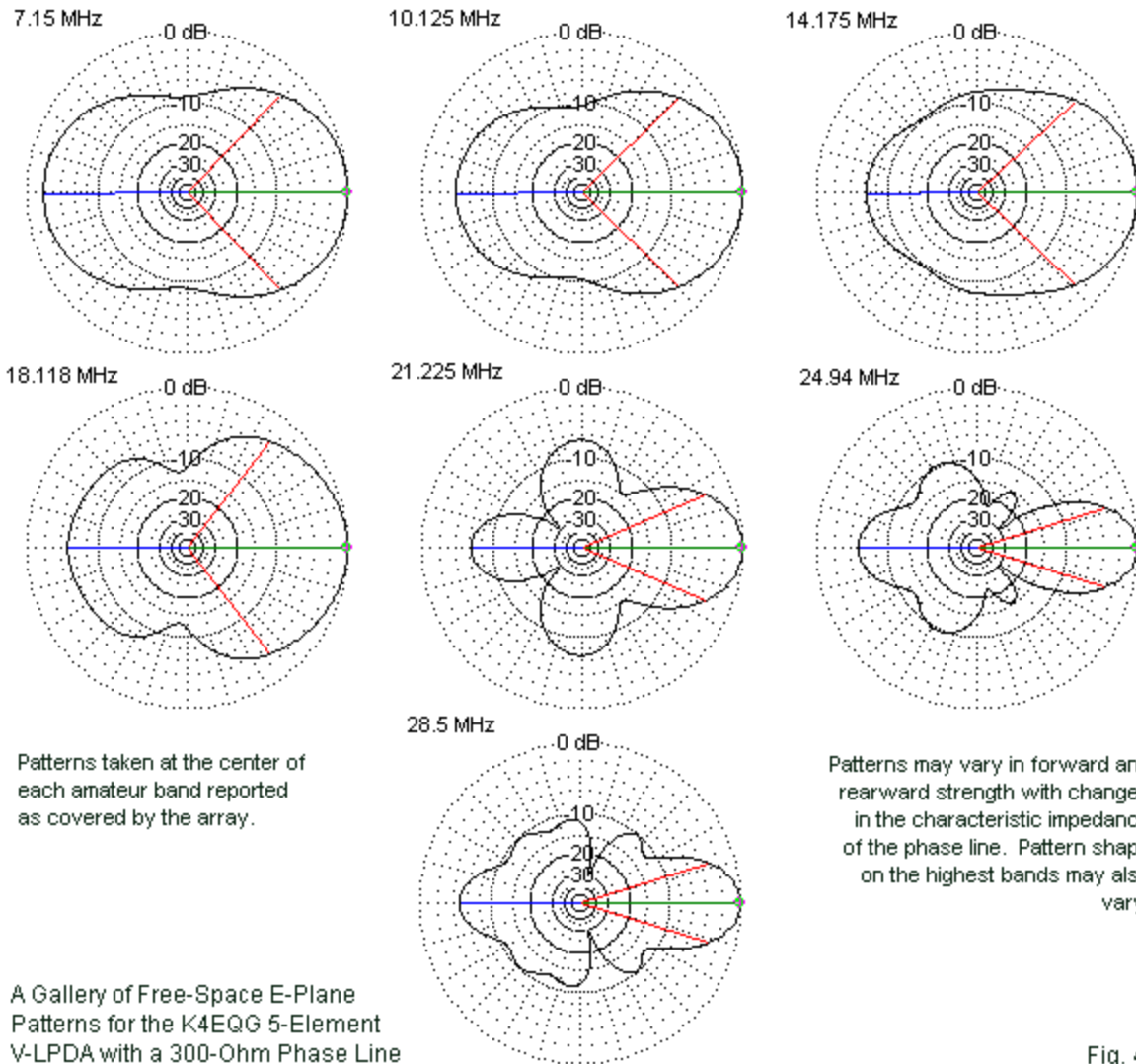

Fig. 4

Pattern shapes for the prototype also tend to show considerable variation as we change the value of the phase-line impedance. See **Fig. 5** for a sample of 28.5 MHz patterns. Note the differences in both the forward and rearward pattern structures.

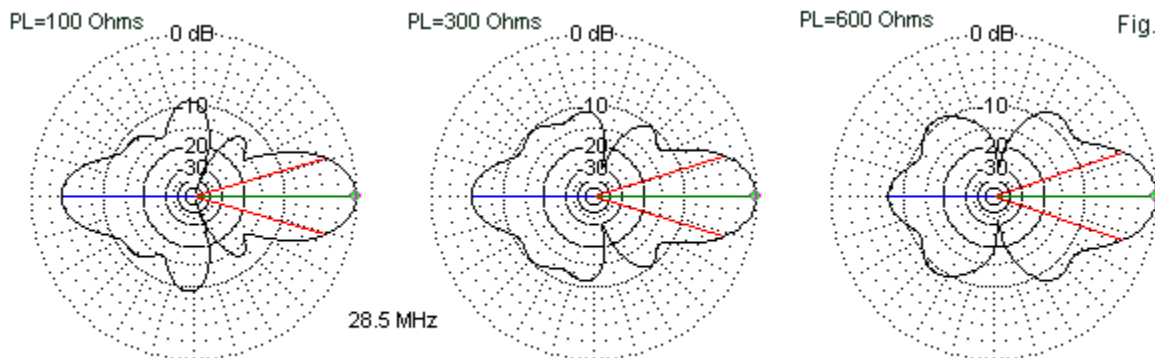

Fig. 5

28.5-MHz Free-Space E-Plane Patterns for a V-LPDA with Different Phase-Line Characteristic Impedance Values

Perhaps the key difficulty underlying the K4EWG array is the tendency to try to accomplish the most from an array using the absolute least aluminum possible. The K4EWG array fails to clearly show the principles of a V-LPDA largely due to the use of too low a value for τ and a resulting apex angle that is too wide for effective performance at any frequency. Although it might be convenient simply to create a more adequate design, we should pause to improve our understanding of higher-order dipole element operation and the importance of creating V-structures for the elements when we operate them in the higher-order mode.

V-Dipoles in the $\frac{1}{2}\lambda$ and the $\frac{3}{2}\lambda$ Modes

The properties of a dipole largely determine the properties of LPDAs that we construct with them. Therefore, we may usefully review both straight and V-dipole elements. We have a second motivation for looking at dipoles, since we are interested in operating them at both their fundamental resonance frequency (or mode) and at one higher mode: the frequency of resonance when the dipole is $\frac{3}{2}\lambda$ long. At the higher frequency, we may discover that some values of ψ and ψ' yield better results than others.

Fig. 6

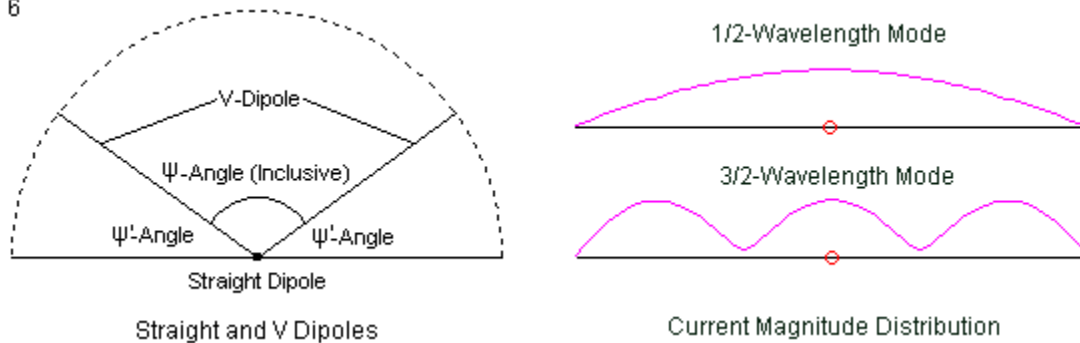

With respect to dipoles, **Fig. 6** shows once more the meanings of ψ and ψ' . On the right, the graphic shows the differences in current distribution between operation at the fundamental and at the $\frac{3}{2}\lambda$ mode of operation. In both cases, the dipoles will be resonant, that is, have a purely resistive impedance. The feedpoint impedance at each higher mode of operation will be higher than the previous mode. We should also note in passing that the length of a half-wavelength at the higher frequency is about—but not exactly— $\frac{1}{3}$ of the length of the dipole at its fundamental mode. This fact will play a significant role when we eventually re-design a V-LPDA.

As we increase the V-angle, that is, the value of ψ' , the included angle grows smaller, as does the distance between the tips of the V-dipole. When the value of ψ' is between 30° and 40° (for values of ψ between 120° and 100°), we find the highest gain values when operating the antenna in the $\frac{3}{2}\lambda$ mode, as shown in **Table 2**. The distance between tips varies from about 1.3λ down to about 1.15λ . A center-fed straight element of the specified length corresponding to the distance between tips would also show the highest gain as it grew from 1.0λ to 1.5λ . Unfortunately, elements that are about 1.25λ (the length of an extended double Zepp antenna) exhibit feedpoint impedance values with very high capacitively reactive components. By increasing the wire length to $\frac{3}{2}\lambda$ but creating a V-structure, we obtain the benefits of higher gain, but with a resonant feedpoint. Element resonance is one of the critical factors in LPDA design. Therefore, LPDAs attempting to operate on a higher mode than the fundamental must use a V-structure. The required value of ψ grows smaller as we increase the mode of operation, although we shall limit ourselves to just the fundamental and the $\frac{3}{2}\lambda$ modes.

V-Dipole	Wire Length 60"					Diameter: 0.1"					Table 2
	1/2-wavelength mode					3/2-wavelength mode					
ψ -Angle	F-1/2	Zres	Gain	F/B	E-BW	F-3/2	Zres	Gain	F/B	E-BW	
0	47.35	72.0	2.14	0.00	78.2	145.15	105.6	3.46	0.00		
30	47.75	58.3	1.83	0.06	84.8	146.30	102.2	5.90	2.44	30.2	
35	47.90	53.6	1.73	0.07	87.4	146.60	104.1	6.00	2.42	32.4	
40	48.10	48.4	1.61	0.07	90.4	146.90	107.4	5.81	2.42	35.0	
45	48.30	42.7	1.48	0.07	94.4	147.00	111.3	5.34	2.43	38.2	
50	48.60	36.8	1.34	0.07	98.8	146.95	114.2	4.66	2.40	42.2	
55	48.90	30.7	1.20	0.06	104.0	146.65	113.8	3.85	2.32	47.6	
60	49.25	24.7	1.06	0.07	110.4	146.20	108.1	2.98	2.15	55.4	

Bold-Face = peak values in the 3/2-wavelength mode

The table shows other interesting features of V-structure elements at both modes. Note the entry for a straight dipole as a reference. As illustrated in **Fig. 7**, the relationship between the fundamental and the 3/2-mode frequencies is almost but not quite constant. The ratio averages about 3.05:1, largely because the higher-mode situation has only 2 free ends for 3 half-wavelengths. More dramatic is the fact that as we increase the value of ψ , the fundamental mode impedance steadily decreases. In contrast, the 3/2-mode impedance increases until we pass a ψ -angle of about 50° . The consequence is that the narrower the V (the smaller the value of ψ), the greater will be the difference between the fundamental and the 3/2-mode impedances. This fact poses a problem or a limitation on the creation of V-LPDAs designed to operate in both modes. Some designers try to employ the geometric mean between the two impedance values, although this technique tends to work best (that is, to produce the lowest SWR values in each region of the spectrum) where the value of ψ is smallest and the difference between feedpoint impedance values is least for the two modes.

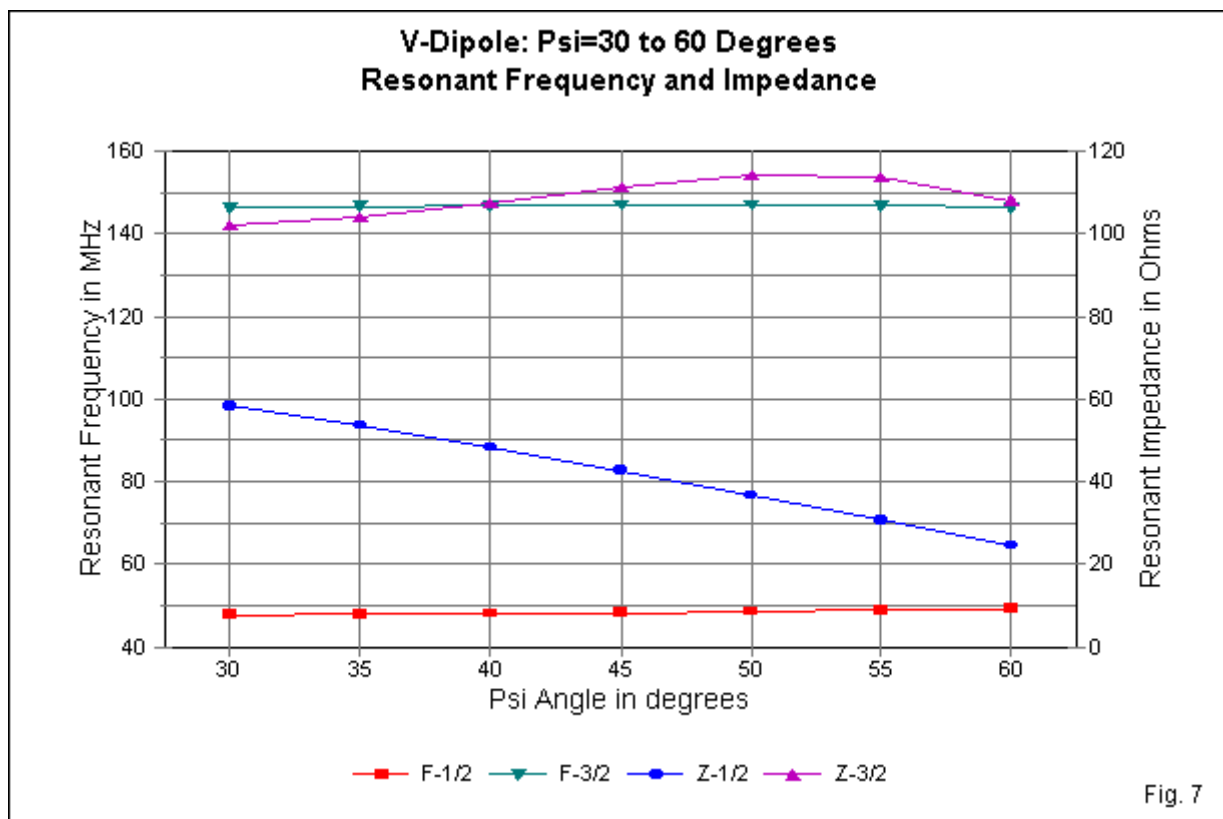
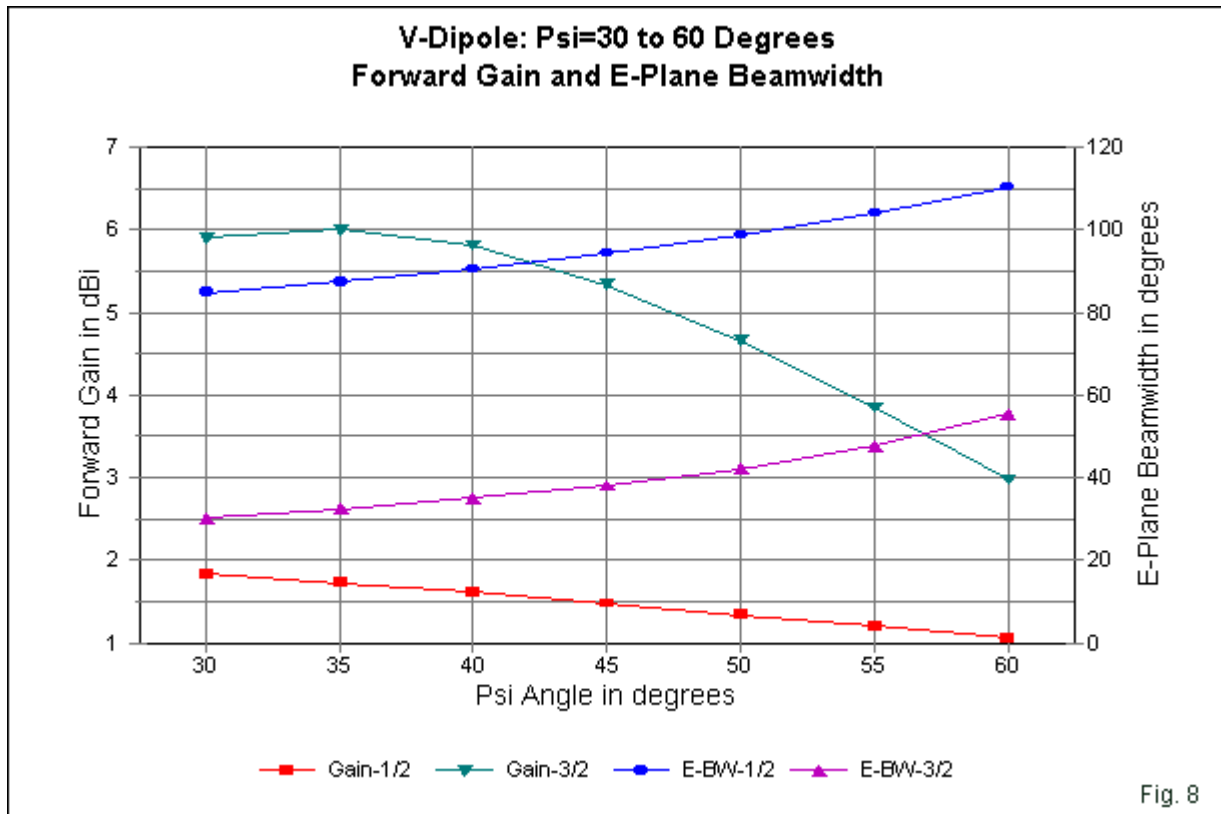

Fig. 7

Fig. 8 graphs the maximum gain and the E-plane beamwidth of the structure at each sampled value of ψ' for both modes. In the fundamental mode of operation, the gain steadily decreases with increasing values of ψ' . Thus, in the fundamental mode, the straight dipole always shows more gain than a V-dipole, regardless of the V-angle. In contrast, the $3/2\text{-}\lambda$ mode shows a peak gain between 30° and 40° as the operative values of ψ' . Narrower ψ -angles, which might favor higher modes of operation, show decreasing gain. Without some means of varying the ψ -angle as we raise the operating frequency, we may find limits in the ultimate frequency span that we can cover with a V-LPDA.



The E-plane beamwidth curves in **Fig. 8** shows one of the few parallel paths among the sampled values of V-angles. Both sets of beamwidth values show upward curves with decreasing values of ψ , that is, narrower Vs. In all cases, the difference in the beamwidth values is about 55° . Note from the table that in all cases, the beamwidth of the V-dipoles is wider than the beamwidth of a straight dipole when both operate in the fundamental mode. The additional directivity ascribed to V-LPDAs derives from operation in a higher mode than the fundamental and statements about improved directivity apply only to higher-mode operation. In fact, in the fundamental mode, converting a straight element into a V-element always yields less directivity, whether the concern is gain or beamwidth.

From the table, we can also glean the fact that for both the fundamental and the $3/2\text{-}\lambda$ modes, the V-dipole shows a small front-to-back ratio, where we define the front as the open end of the V. At the fundamental mode frequency, the ratio is truly minuscule and only numerically noticeable in models. At the $3/2\text{-}\lambda$ -mode frequency, the difference is smaller but would be operationally detectable, at least under well-designed test conditions. Since all V-LPDAs show gain in the same direction, the small differential becomes an advantage to performance.

As we gradually increase the value of ψ' and thereby reduce the included V-angle, we also find changes in the E-plane pattern for the array. **Fig. 9** samples the changes using ψ' values of 30° , 45° , and 60° . When operated in the fundamental mode, the V-dipole simply shows a decrease in the null off the wire ends (or 90° from the axis of maximum gain). When operated in the $3/2\text{-}\lambda$ mode, the patterns are far more variable, but show a reasonable progression. At $\psi' = 30^\circ$, the antenna shows a pattern very much like the pattern of an extended double Zepp, but with an offset in the direction of maximum gain. As we increase the value of ψ' , the smaller side lobes merge to form what some have called "ears." Further increases in the value of ψ' result in a final merging as well as increased side-lobe strength. As a result, when $\psi' = 60^\circ$, the side lobes are nearly as strong as the forward lobe and stronger than the rearward lobe.

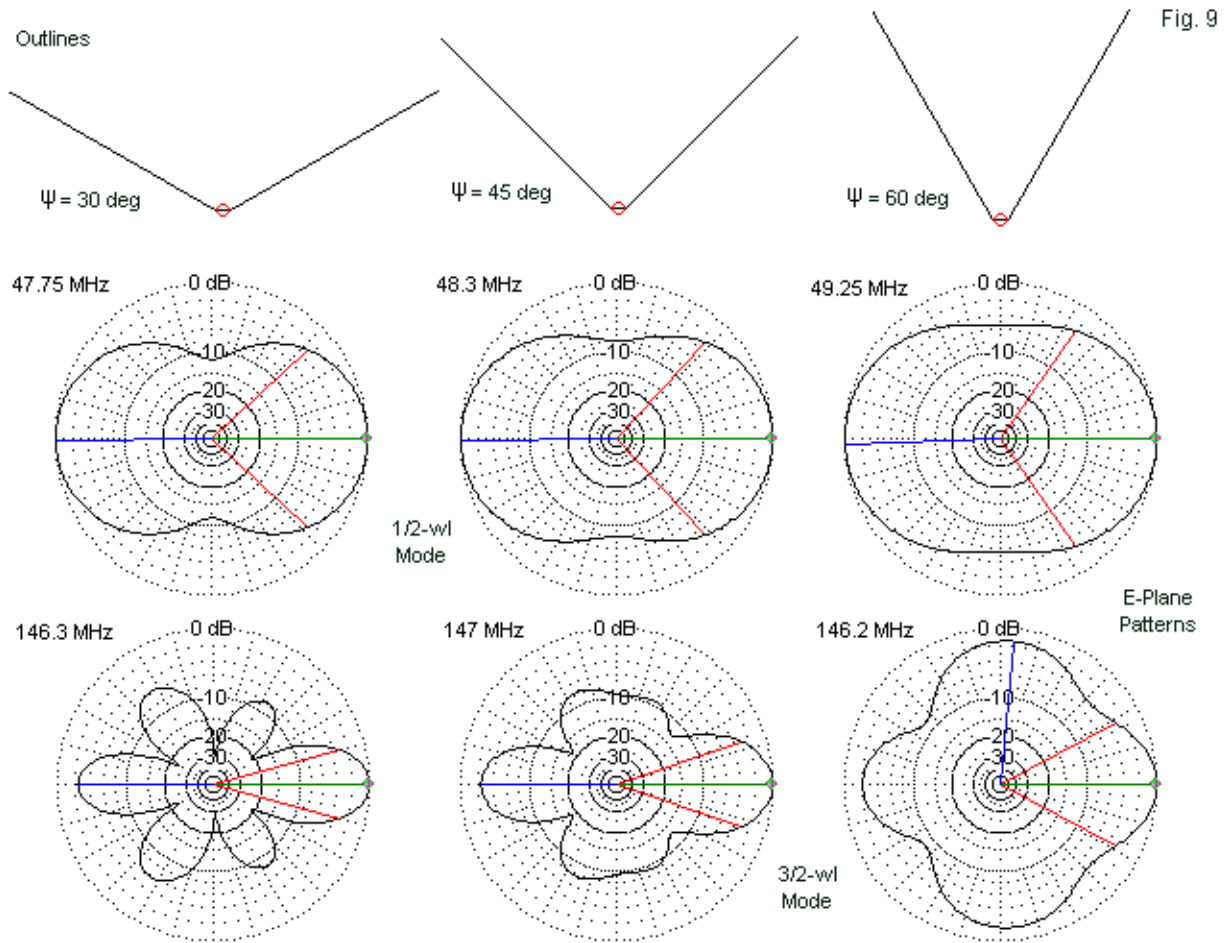

Sample Free-Space E-Plane Patterns of V-Dipoles in the 1/2- and 3/2-Wavelength Modes

The shift in pattern shape adds a dimension to the design considerations for a V-LPDA. The array designer must select a ψ -angle that yields the best compromise among gain, relative impedance values in each mode, and the pattern shape most likely to yield performance meeting the application needs. In general, ψ' angles between 35° and 45° tend to be most favored for arrays operating in both the fundamental and the $3/2\text{-}\lambda$ mode.

The performance of V-elements operating in the $3/2\text{-}\lambda$ mode is generally well known among designers. In fact, we can find some parasitic beams that employ the technique. There is a commercially made 3-element parasitic beam composed of just such elements, following what

some call of the G0GSF design. **Fig. 10** provides a glimpse at its outline and the general pattern that we can expect of such arrays. Although the wire-length of the elements is 1.5λ , the aperture length is closer to 1.25λ . As a result the array displays a pattern similar to one we might obtain using straight extended double Zepp elements. The relatively close spacing of the reflector to the driver produces a relatively low feedpoint impedance, but one that we can bring to $50\text{-}\Omega$ by standard methods. The forward gain is about 3-dB higher than the gain from a standard Yagi that employs $\frac{1}{2}\lambda$ elements.

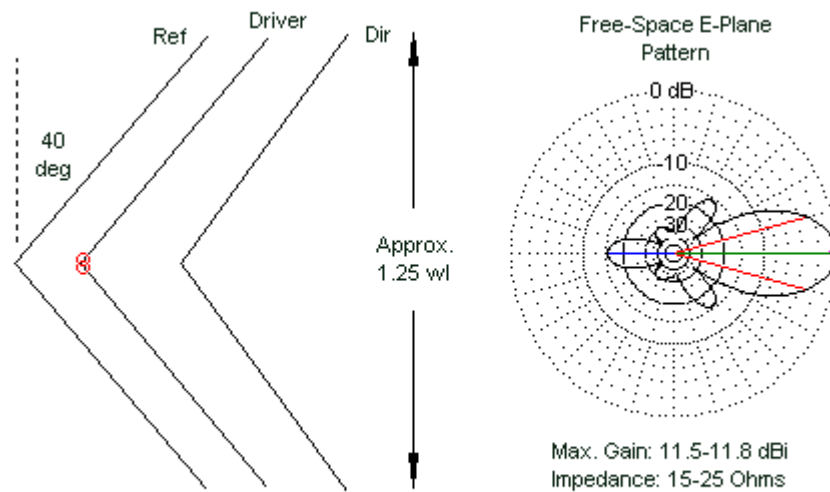

Fig. 10

The G0GSF 3-Element Parasitic V-Beam

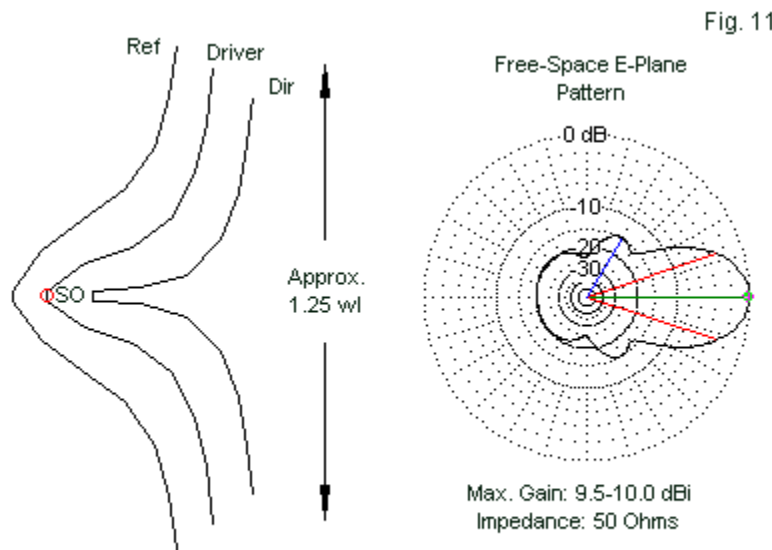

Fig. 11

The Landstorfer-Sacher 50-Ohm "EDZ" Parasitic Beam

In **Fig. 11**, we have an interesting modification of the process of creating a 3-element parasitic beam from elements that are about 1.5λ long. Like the G0GSF array, the Landstorfer-Sacher array has an aperture of about 1.25λ . However, the designers have altered the

geometry of the elements to produce a 50- Ω feedpoint impedance. In addition, the modifications to the element shapes sacrifice some gain in the interest of producing a pattern with a minimum level of forward and rearward sidelobe development. The result is an array that always arouses high interest, but virtually no replication.

These quick samples of parasitic arrays using elements operated in the $3/2\text{-}\lambda$ mode simply illustrate the fact that higher-order use of center-fed wires forming a V (or some variant of a V) have longstanding uses in antenna fabrication. The uniqueness of the Mayes and Carrel patents lies in their application of V-elements to LPDA design.

A Test V-LPDA Model and Its Performance

With the nature and limitations of V-dipoles at our disposal, we may embark upon the design of a test case V-LPDA in order to see more clearly its performance properties. The proper frequency range for such an antenna may be 49 to 90 MHz, the spectrum occupied by the lower VHF television channels. One of the motivations behind the development of the V-LPDA was the goal of designing an LPDA that would cover both this lower spectrum of television and its upper spectrum extending from 174 to 215 MHz—without requiring separate element sets for each portion of the TV channel allocations. Interestingly, the two segments of the spectrum have an approximate 3:1 frequency relationship. Therefore, a V-LPDA designed for fundamental coverage of the lower channels should perform quite well on the upper channels. In fact, the increased gain of elements operating in the $3/2\text{-}\lambda$ mode should go some distance in overcoming the increased path losses of the higher region, a concern in the days of fringe area reception.

We may begin with the design of a straight element LPDA to determine the most usable values of τ and σ . One of the difficulties inherent in the K4EWG array was the low value of τ . To overcome this difficulty, I selected a value of 0.96. The higher value of τ ensures a sufficient element population to provide good performance in the fundamental mode. **Fig. 12**, on the left, shows the outline of the straight element LPDA.

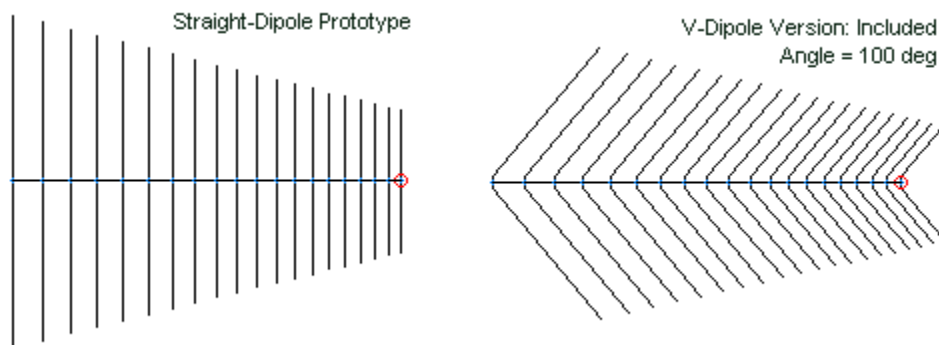

20-Element Straight- and V-Dipole Outlines: 49-90 MHz LPDAs Fig. 12

The array employs 20 elements on a 140" boom. Although the boom is too long for practical television reception from the average rooftop, it allows the use of a proper value of σ . The value of σ is 0.045. Some amateur literature points out the recommendation for using lower values of σ rather than the optimum value of σ , but give no reasons. In fact, the reason is simple. When we create a V-LPDA, as shown on the right in **Fig. 12**, we shall operate the array in the $3/2\text{-}\lambda$ mode. The operative design length of each element is only about $1/3$ as long, although each element has 3 such half-wavelengths. The calculation of an optimal value for σ rests on the

length of a $\frac{1}{2}\lambda$ elements. Hence, on the upper frequencies, the effective value of σ is three times the value on the lower frequencies, or about 0.135. For a τ of 0.96, this value is close to but below optimum in the interests of limiting the number of elements and the boom length.

V-prototype											Table 3	
Tau		0.96									Sigma	0.045
Alpha	degrees	27.68	degrees	0.483	radians	1/2Alpha	0.242	tanAlpha	0.2464			0.045
F-low		49.00	MHz									
F-high		90.00	MHz									
L-long		3.06	meters	10.04	feet	120.52	inches					
Lhigh		1.67	meters	5.47	feet	65.62	inches					
L*1.6		1.04	meters	3.42	feet	41.01	inches					
Rv	Vertex R	6.21	meters	20.38	feet	244.60	inches					
Element	Ln	Ln/2	Rn	Element	Lfeet	Lft/2	Rfeet	Element	Linch	Lin/2	Rinch	
1	3.061	1.531	6.213	1	10.04	5.02	20.38	1	120.52	60.26	244.60	
2	2.927	1.463	5.939	2	9.60	4.80	19.49	2	115.22	57.61	233.84	
3	2.798	1.399	5.678	3	9.18	4.59	18.63	3	110.15	55.07	223.55	
4	2.675	1.337	5.428	4	8.78	4.39	17.81	4	105.30	52.65	213.71	
5	2.557	1.278	5.189	5	8.39	4.19	17.03	5	100.67	50.33	204.31	
6	2.444	1.222	4.961	6	8.02	4.01	16.28	6	96.24	48.12	195.32	
7	2.337	1.168	4.743	7	7.67	3.83	15.56	7	92.00	46.00	186.72	
8	2.234	1.117	4.534	8	7.33	3.66	14.88	8	87.96	43.98	178.51	
9	2.136	1.068	4.335	9	7.01	3.50	14.22	9	84.09	42.04	170.65	
10	2.042	1.021	4.144	10	6.70	3.35	13.60	10	80.39	40.19	163.15	
11	1.952	0.976	3.962	11	6.40	3.20	13.00	11	76.85	38.42	155.97	
12	1.866	0.933	3.787	12	6.12	3.06	12.43	12	73.47	36.73	149.10	
13	1.784	0.892	3.621	13	5.85	2.93	11.88	13	70.24	35.12	142.54	
14	1.705	0.853	3.461	14	5.60	2.80	11.36	14	67.15	33.57	136.27	
15	1.630	0.815	3.309	15	5.35	2.67	10.86	15	64.19	32.10	130.28	
16	1.559	0.779	3.163	16	5.11	2.56	10.38	16	61.37	30.68	124.54	
17	1.490	0.745	3.024	17	4.89	2.44	9.92	17	58.67	29.33	119.06	
18	1.425	0.712	2.891	18	4.67	2.34	9.49	18	56.08	28.04	113.83	
19	1.362	0.681	2.764	19	4.47	2.23	9.07	19	53.62	26.81	108.82	
20	1.302	0.651	2.642	20	4.27	2.14	8.67	20	51.26	25.63	104.03	

Table 3 provides the dimensions for the straight-element version of the LPDA. Note that the shortest element of the 20 is between the self-resonant length at 90 MHz and the self-resonant length at 1.6 times the highest frequency covered in the fundamental mode. We may therefore expect to see a small decline in performance at the upper end of the standard LPDA spectrum. We shall be interested in seeing if this decline carries over into the V-LPDA version of the array. For modeling reasons related to the use of the V-LPDA at higher frequencies, I set the element diameter to 0.1". The combination of a thinner element and a low value of σ in the 50-90-MHz span does deprive the array of the absolute maximum gain that we might obtain from 20 elements and a τ of 0.96, but it does ensure that the models trigger no NEC-4 warnings at any sampled frequency. The phase line has a characteristic impedance of 200 Ω .

For reference, **Fig. 13** shows the free-space forward gain and the 180° front-to-back ratio of the LPDA with straight elements. The graph uses 2.5-MHz increments between 50 and 90 MHz. As expected, the average gain decreases from about 8.5 dBi at the lower end of the span down to about 7.7 dBi at the upper end. The front-to-back ratio shows a parallel decline, although the minimum value is greater than 20 dB.

The feedpoint performance values appear in **Fig. 14**. In general, the values are very well behaved across the sweep limits, with only one small spike in the SWR to a level just below 1.8:1 relative to the 100- Ω reference standard. As we might anticipate from the mild decreases in gain and front-to-back performance at the high end of the spectrum, we also find increasing variations in the feedpoint resistance and reactance in the same region.

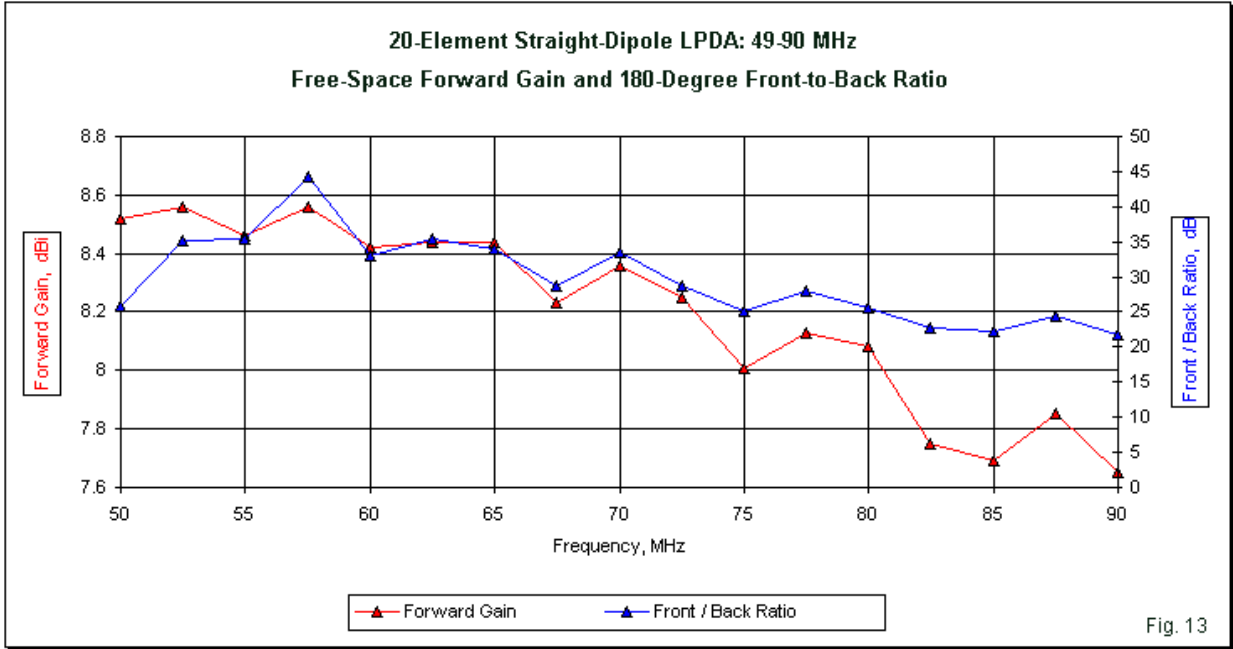

Fig. 13

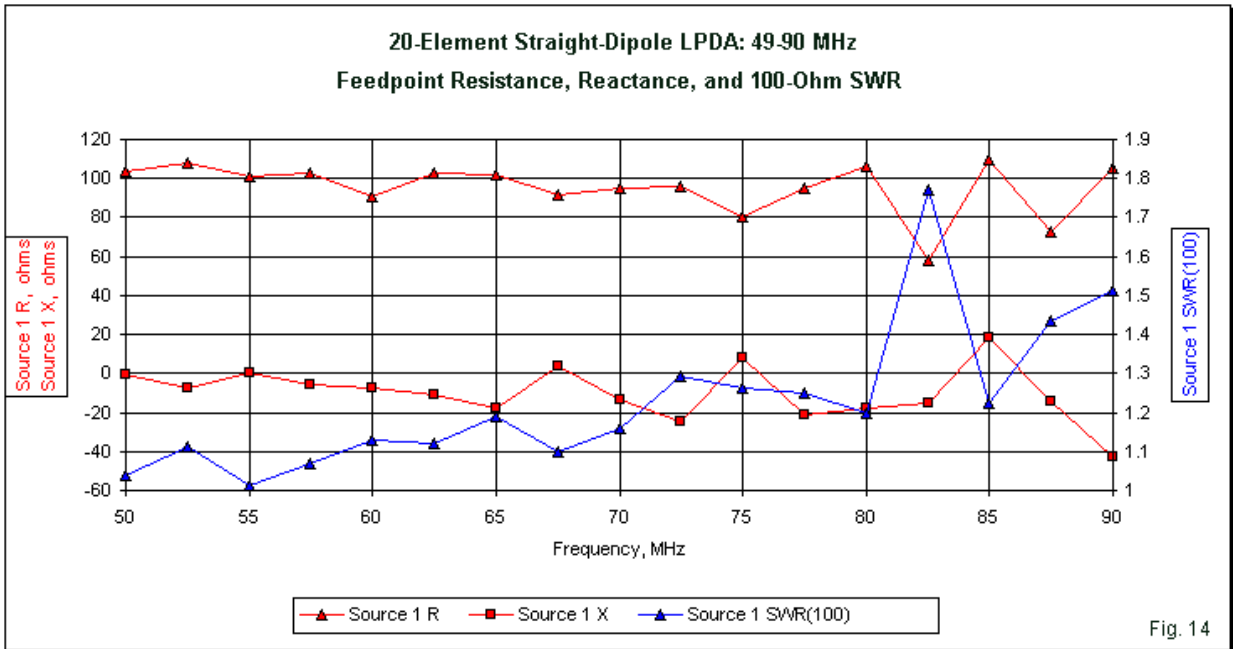

Fig. 14

The straight element version of the LPDA is only useful in the lower TV range. However, we may sweep the elements forward to a ψ' angle of 40° (for an included angle of 100°) and operate the array on both sets of VHF channels. We shall make no other changes in the array. The process of creating a V-LPDA does change the overall apex angle. The design angle of 27.7° decreases to 25.4° .

Fig. 15 presents the sweep of the lower VHF TV region so that we may compare the results with those in **Fig. 13**. The V-LPDA shows below average gain at the low end of the spectrum, suggesting the need for a slightly longer rear element. The general curve also replicates the

gain decline at the upper end of the spectrum. Moreover, the average gain of the V-LPDA is more than a full dB less than the average gain of the straight element counterpart. In contrast, the front-to-back curve shows its lowest value at the low end of the sweep but sustain very good values across the entire operating range.

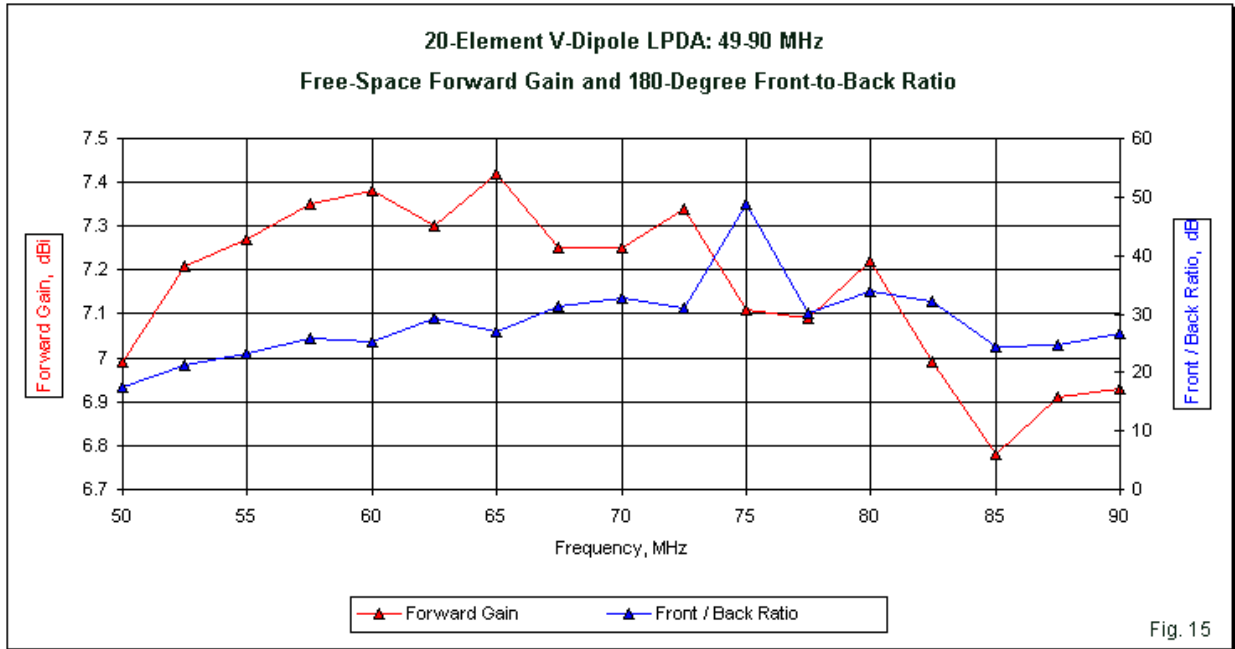

Fig. 15

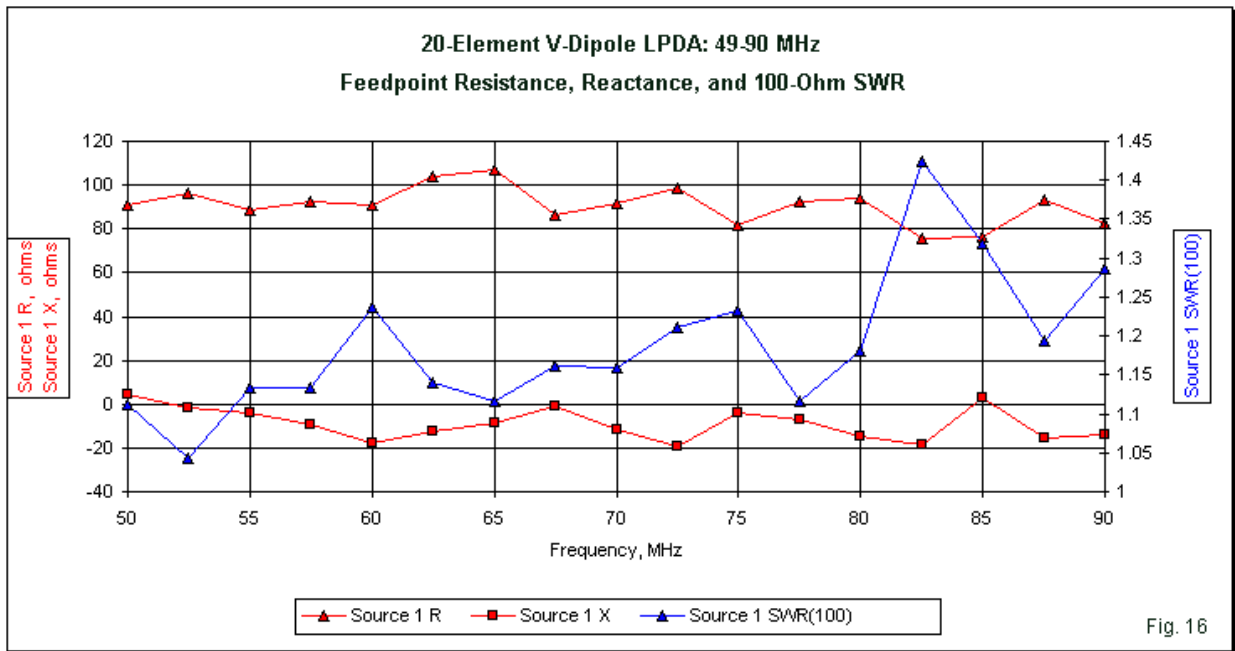
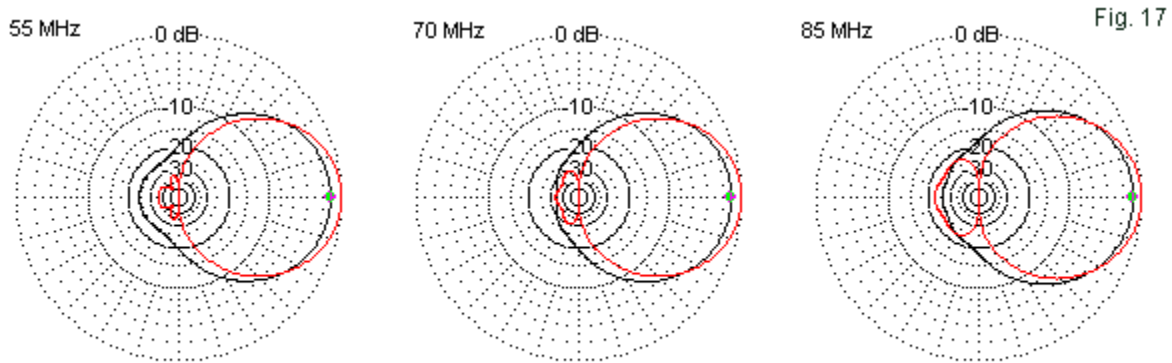

Fig. 16

The V-LPDA feedpoint values, shown in **Fig. 16**, are equally as well behaved as those for the straight element version. The average value of feedpoint resistance is slightly lower in the V-LPDA, but the reactance curve tends to be smoother. Hence, the peak SWR (within the limits of sampling) is lower than for the straight element LPDA.

An alternative method of comparing the straight and V versions of the LPDA is to sample the free-space E-plane patterns, as shown in **Fig. 17**. The plots overlay both patterns at each frequency and clearly show the gain advantage of the straight LPDA over the V-LPDA when both operate in the fundamental mode. In contrast, the V-LPDA shows a more consistent rearward radiation pattern, although the differences tend to be less than significant in practice.



Sample Free-Space E-Plane Patterns: Overlaid Patterns of the Straight-Dipole and V-Dipole LPDAs

Less evident in the sample patterns is the narrower beamwidth of the straight element LPDA relative to the V-LPDA. Therefore, **Fig. 18** tracks the two sets of values through the sweep range. The standard LPDA averages about 10° narrower E-plane beamwidth across the entire spectrum.

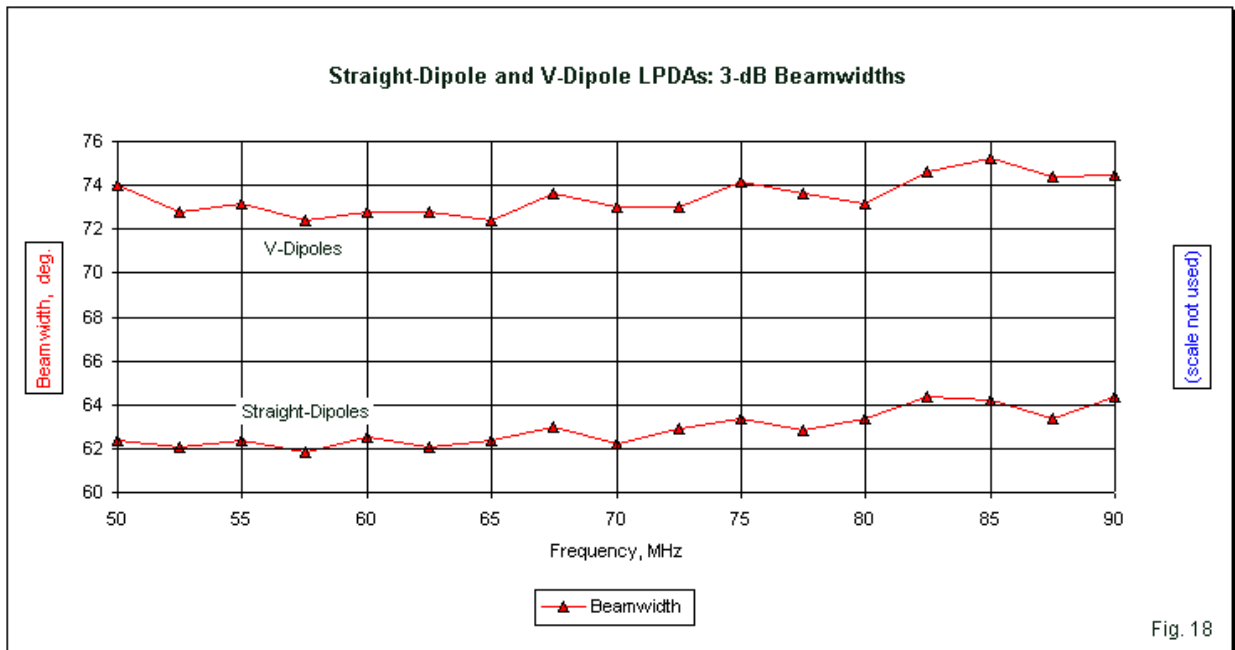

Fig. 18

Unlike the straight element LPDA, the V-LPDA will cover the upper VHF TV channels from 174 to 216 MHz. For these channels, I set up a sweep covering 170 to 200 MHz in 5 MHz increments. The gain and front-to-back data appear in **Fig. 19**. The gain runs from 8 to 10 dBi, an average of perhaps 2 dB higher than the low-range average gain. The 180° front-to-back

ratio remains uniformly high across the spectrum except for one oddly low value at about 215 MHz.

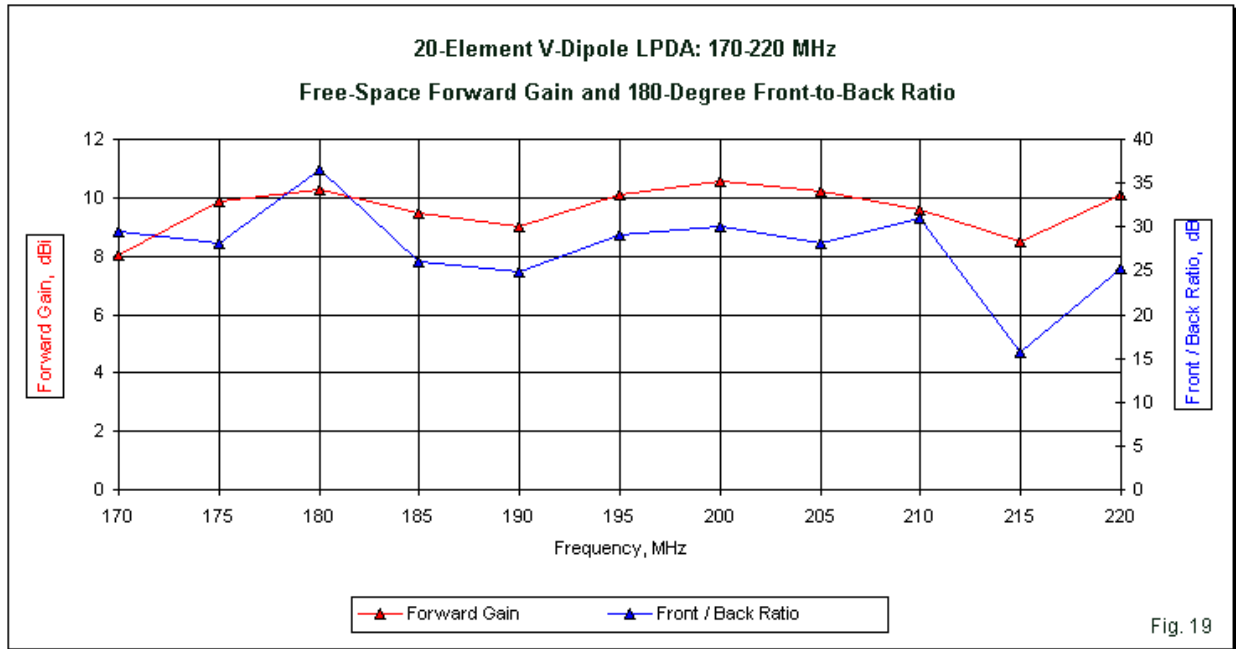

Fig. 19

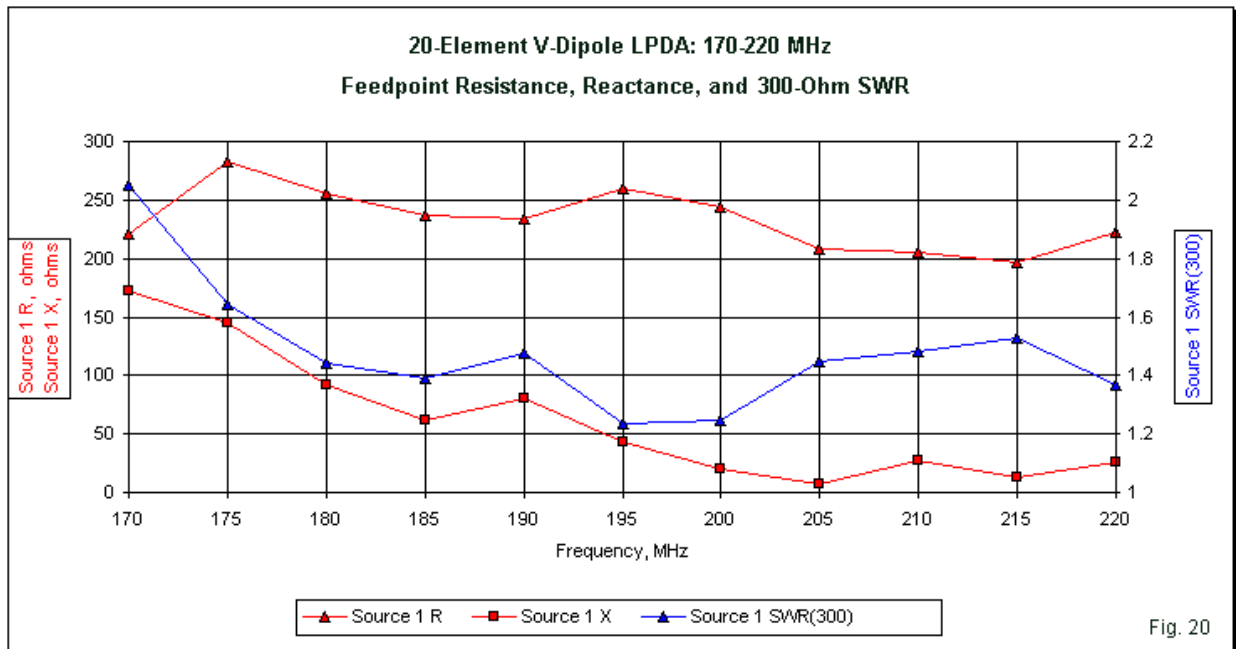

Fig. 20

Fig. 20 provides the corresponding feedpoint information. The resistance is rather flat across the band covered by the sweep, although the reactance shows a descending curve that does not level off until about 200 MHz. The resulting SWR curve shows only one small excursion above 2:1, and that occurs at the low end of the sweep below the start of the high-VHF TV channels.

The only significant challenge offered by the feedpoint properties is the fact that they reference 300 Ω for the SWR values. The resistive component of the impedance fluctuates between 200 and 300 Ω , in contrast to the low-range values of 75 to 110 Ω . It is not clear that a compromise reference of about 175 Ω (the geometric mean between the reference values used in each range) would result in satisfactory SWR performance. Television receivers of the era tended to have less stringent input impedance SWR requirements than we encounter in amateur practice, and so SWR values up to and possibly in excess of 3:1 were common in many television antenna designs. It is also possible that the selection of other phase-line impedance values may draw the two sets of feedpoint data closer together.

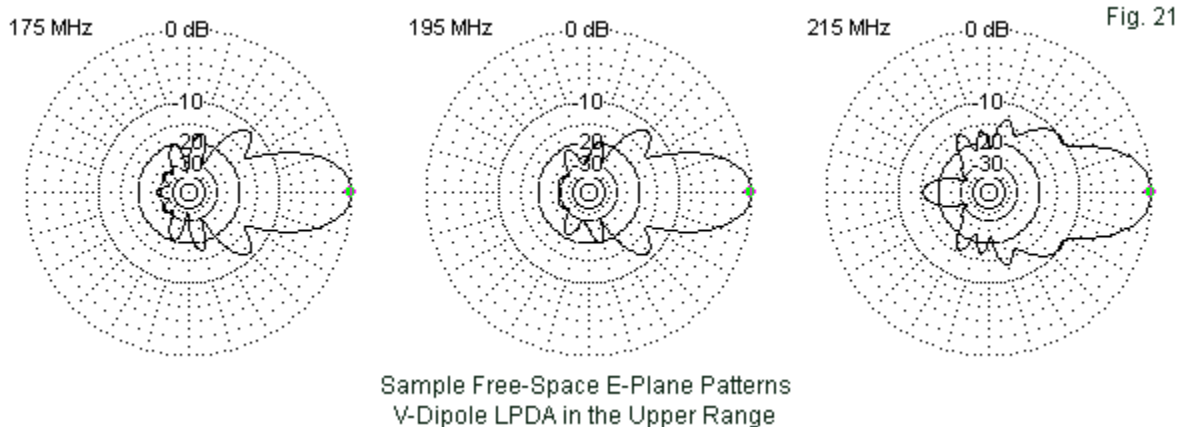

Fig. 21 presents three sample free-space E-plane patterns in the upper TV channel range. Beamwidth values run from 29° at the low end of the sweep up to 34°. Combined with the gain information, the patterns and graphs confirm the claim of greater directivity of operation on the higher ($3/2\text{-}\lambda$) mode. Although the patterns show strong resemblances to each other, we find some significant variation in shape, especially as we approach the upper end of the operating range. Because the V-LPDA is a periodic (and not a continuous) structure, there will always be some variability in pattern shapes as we sample patterns in small increments of frequency change. Because higher-mode operation with V-dipoles always produces sidelobe structures, these lobes will make the changes more apparent than the single-lobe structures that occur during fundamental operation. Whether the sidelobes are significantly strong is a judgment that requires the imposition of criteria provided by application specifications.

We may confirm that the array is operating in the fundamental mode on the lower range and in the $3/2\text{-}\lambda$ mode on the upper range by comparing current magnitude distribution curves for each range. **Fig. 22** provides a comparison between the current distribution at 70 MHz and at 195 MHz, the midpoints of each frequency sweep. The upper free-ends of the curves represent the current peak at the phase line, since the symmetrical curves for each side of the line overlay each other. Although smaller curves may be difficult to trace due to the forward sweep of the V-dipoles, the highest values reveal their structures easily.

The curves for 70 MHz are all single traces extending from a minimum value to a peak at the center of the elements. The most active elements show themselves prominently. Behind those elements, the rearward Vs show current levels that quickly diminish to uniformly insignificant levels. Ahead of the most active elements, we find periodic peaks and valleys, but all elements are significantly active all the way to the front-end of the array. These behaviors are coincident with the current distribution patterns that we encounter with straight element LPDAs.

Current Magnitude Distribution on a 20-Element V-Dipole LPDA Mid-Band in the Lower and the Upper Ranges of Operation

Fig. 22

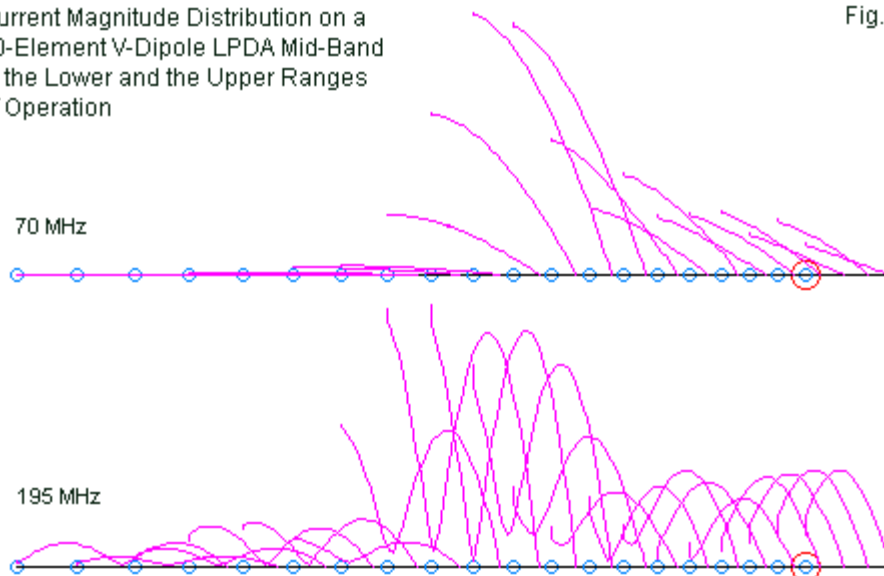

In the upper region of the spectrum, at 195 MHz, the current distribution is quite different. Each of the most active elements shows 1-1/2 curves (with the other 1-1/2 curves hidden by the orientation of the graphic). Forward of the most active elements, we find incomplete curves relative to the anticipated pattern. Nevertheless, the relative current peaks are as strong as those for the forward elements of the 70-MHz graph. Unlike the graph of the lower-region rear elements, the upper-region rear elements maintain an interesting level of activity. The activity is not strong enough to seriously affect performance, but it may contribute to the complex rear lobe structures that we saw in **Fig. 21**.

By careful design, the V-LPDA design with which we have been working has achieved its goals for television reception (with the possible exception of an acceptable compromise feedpoint impedance reference). It has served to demonstrate the validity of the claim of the inventors that it is possible to design an antenna suited for wide-band performance on two separate but inter-related portions of a frequency spectrum. By using the fundamental and the $3/2\text{-}\lambda$ modes in concert, the design shows precisely the performance expected by the inventors. It has done so by the use of a high value of τ to ensure basic performance and a low value of σ to ensure close to optimal σ at the upper range and equally to ensure a finite boom length.

One of the apparent misunderstandings among radio amateurs when first encountering such designs presented in highly compressed ways was to assume that the coverage from the low to the high end of the operating range was continuous. This assumption is not necessarily correct, and for the present design is clearly false.

Fig. 23 supplies the missing graph of frequencies between 90 and 170 MHz in 5 MHz increments. The gain data shows a steady decline to about 135 MHz, where forward gain approximates a simple dipole. The 180° front-to-back ratio continues downward for another 5 MHz (to 140 MHz, where the value is less than 4 dB). The rise in values from their minimum levels occurs because $3/2\text{-}\lambda$ operation is just beginning to take hold. However, as we have seen from **Fig. 19**, the higher mode does not stabilize until the frequency is greater than 170 MHz.

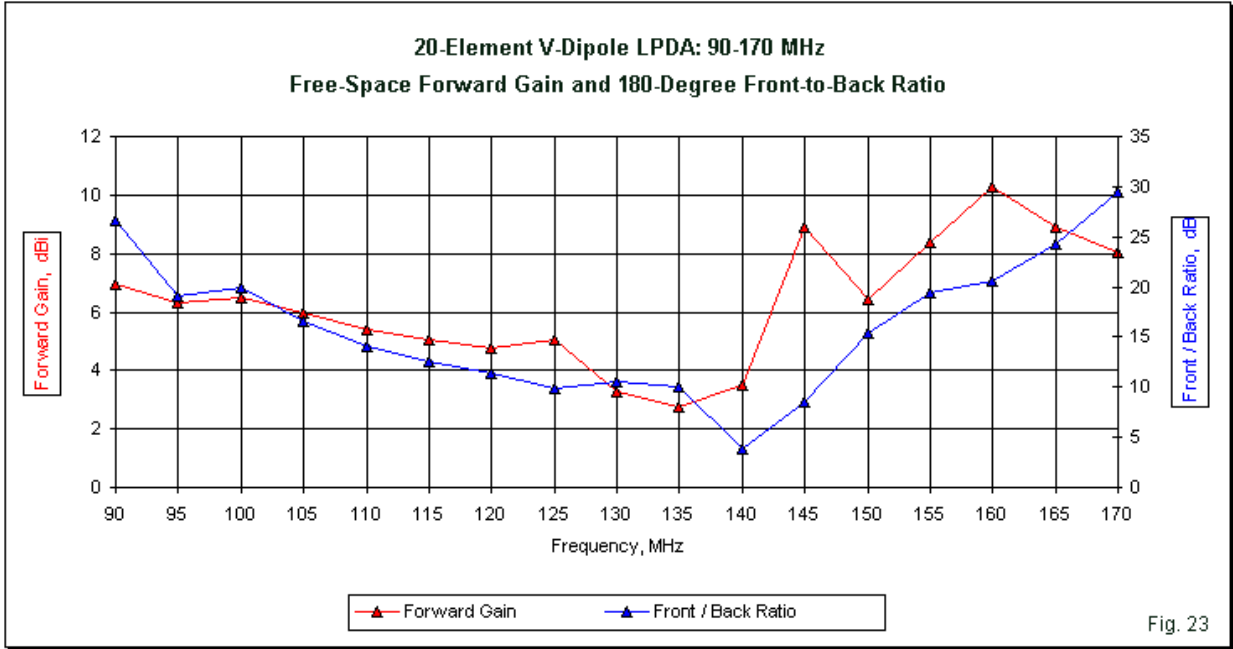

Fig. 23

Part of the stabilization process involves obtaining a feedpoint impedance that is compatible with the values obtained earlier. However, in the intervening frequencies from 110 to 135 MHz, the feedpoint resistance hovers close to zero. In the same span, the inductive reactance climbs from near zero to above $j100 \Omega$. The graph shows no SWR line because no sensible reference level is possible.

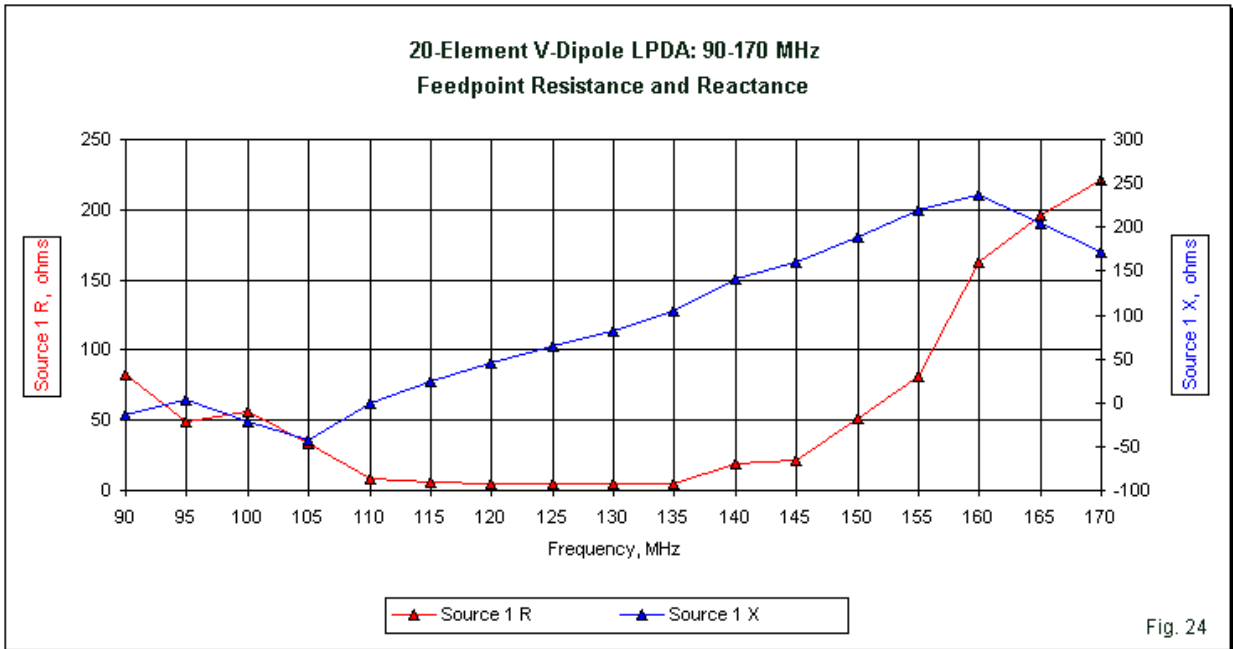
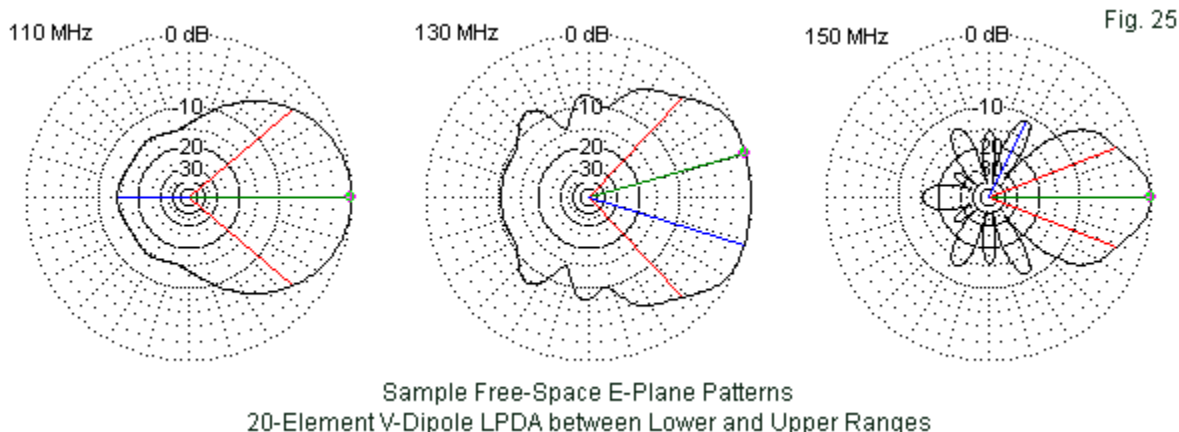

Fig. 24

The free-space E-plane pattern also undergoes radical changes, as evidenced by the sample plots in **Fig. 25** for 110, 130, and 150 MHz. Before one can declare the patterns to be

simply weak but usable, one must compare their shape to the forward gain values that mark the plot outer ring limits.



Re-design of the V-LPDA to try to fill the intervening frequencies is not necessarily a simple or a straightforward task. At some frequency—best left as an unused frequency between the lower and the upper frequency regions—the longest elements will begin to operate in the $3.2\text{-}\lambda$ mode while the shortest element continue to operate in the fundamental mode. **Fig. 26** shows what happens as reflected in the relative current magnitude distribution and in the free-space E-plane pattern.

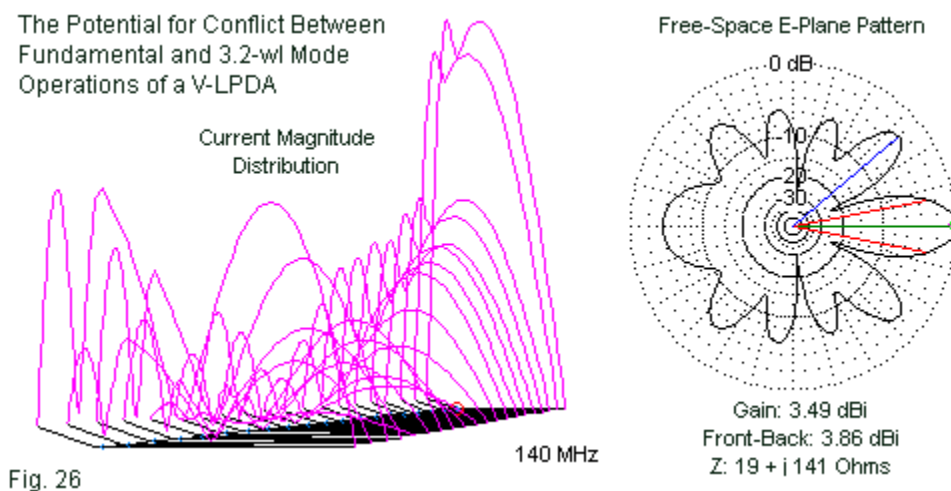

The rear-most element shows the 3 current peaks that indicate $3/2\text{-}\lambda$ operation, while the shortest two elements operate just above their self-resonant points—as indicated by the small dip in current magnitude at the center of both elements. The result is the E-plane pattern to the right, with virtually equal energy fore and aft of the centerline. The very low gain, front-to-back, and impedance values show the non-utility of conditions at 140 MHz in the present model.

In the end, the multi-mode V-LPDA is generally not a vehicle for continuous coverage from the lowest usable frequency in the fundamental mode to the highest usable frequency in the $3/2\text{-}\lambda$ mode. Rather, the best use of the multi-mode V-LPDA may be to cover separate frequency range with an interval of unused frequencies between them.

Conclusion

We have explored—however incompletely—the performance of V-LPDAs, beginning with an over-simplified amateur version that used too low a τ to produce a demonstration of how these antennas actually do their work. To begin the process of understanding V-LPDAs, we reviewed the V-dipole operated at various ψ -angles and set to self-resonance in both the fundamental and the $3/2\text{-}\lambda$ modes. Then we transferred those findings to a sample V-LPDA that used 20 elements with a τ of 0.96, a σ of 0.045 relative to the fundamental mode, and an overall α of nearly 28° . The antenna serves the VHF television channels in 2 bands, one from 50 to 90 MHz, the other from 170 to 220 MHz. In the lower range, the V-LPDA showed less gain and wider beamwidths than a corresponding straight element LPDA of the same design. Nevertheless, the performance remained quite usable for the service specified. In the upper frequency range, $3/2\text{-}\lambda$ -mode operation produced higher gain values and narrow beamwidths. In both cases, the impedance levels were stable, but the SWR curves answered to different reference impedance values. The array also displayed the limitation of needing an unused frequency span between the useful regions, since the conflicts between fundamental and $3/2\text{-}\lambda$ operation yielded unusable patterns and impedances.

The demonstration V-LPDA was relatively successful, although it might well undergo design improvements. It overcame the amateur penchant for trying to obtain too much LPDA performance from too few elements by using a high value of τ and a considerable number of elements. It should lay to rest the typical misunderstandings that are common in amateur literature. V-elements do not yield better performance in the fundamental mode than straight elements, regardless of the type of antenna or array. Rather, the improvement in directivity occurs when using higher-order modes of operation. Second, V-LPDAs generally do not provide continuous frequency coverage. V-LPDAs designed for fundamental and $3.2\text{-}\lambda$ service generally cover distinct frequency ranges having roughly a 3:1 ratio.²

Endnotes

1. Patent US 3,108,280 of 1963, reissued as US Re-25,740 in 1965, covers the basic Mayes-Carrel V-LPDA invention. A modification for better overall performance appears in US 3,150,376 in 1964. Other useful articles include the following item: Mayes and Carrel, "Log-Periodic Resonant V Arrays," IRE, Wescon Convention Record, Part 1, 1961. See also Mayes and Carrel, "Logarithmically Periodic Resonant V-Arrays," Antenna Lab. Rep. 47, University of Illinois, 1960, as well as Chan and Silvester, "Analysis of Log-Periodic V-Dipole Antenna," IEEE Trans. AP-23, May 1975. I am indebted to Alois Krischke, DJ0TR, for supplying me with copies of the relevant patent documents. *Rothammels Antennenbuch*, which Alois very capably edits, is a prominent source for many extant amateur LPDA designs.
2. In the same period as the Mayes-Carrel patents, we find a second set of competing patents in the name of Harry Greenberg and assigned to Channel-Master Corporation. US 3,086,206, re-issue Re-25,604, and US 3,163,864 form the basic set of documents. Common to all three patents is a sample design that uses a 30° V-configuration. However, the array uses a constant spacing between elements. Thus, although the element lengths for the Figure-3 device are τ -tapered, the element spacing is not. In addition, each half element for the 4 forward elements from the set of 10 total elements sets a capacitive load at the point of forward bend. The result is an array that models adequately for television coverage on the lower and upper VHF bands. The small number of elements and the variations from standard LPDA design yield both variable gain values and variable feedpoint impedances. The SWR values relative to the 200-300- Ω range are adequate for the TV receiver standard of the 1960s (a 3:1 SWR limit) but would not meet more stringent requirements imposed by amateur transmitting and receiving equipment. Therefore, I have not included this alternative collection of antennas in these notes.

[Click for Biography of LB Cebik](#)



antenneX Online Issue No. 128 — December 2007
Send mail to webmaster@antennex.com with questions or comments.
Copyright © 1988-2007 All rights reserved - *antenneX*©