

How Much Coaxial Cable? A Case Study

L. B. Cebik, W4RNL

Newcomers to amateur radio sometimes encounter wire antenna advertisements that recommend the use of long runs of coaxial cable from the antenna to the equipment. (Mercifully, such ads are rarer than they used to be.) Usually, the advertisements do not say why the long run is necessary, leading to wild guesswork on the part of the newcomer. One popular misconception is that somehow the recommended line length “tunes” the antenna system.

Let’s take a non-commercial antenna design and discover the real reason for using a very long length of coaxial feedline between the antenna and the equipment. Indeed, I might as well give away the ending, since it is no surprise: longer feedlines, especially coaxial cables that are in general use, increase their losses as they grow longer. Increased line losses lead to broader SWR bandwidths for any particular antenna design. We pay a cost for the increased bandwidth when we purchase it in this manner. The losses in the cable represent energy that does not reach the antenna. The effect is to reduce the gain of the antenna system in every direction.

For the newcomer, there may be a number of challenging ideas in the summary statement. First, the gain of the antenna itself—the wire that actually is responsible for the radiation pattern—does not change. Rather, we simply have less transmitted energy at the antenna because we have converted part of what emerged from the transmitter into heat. (Likewise, energy received has partly converted into heat on the way to the receiver so that signal strength at the receiver terminals is less than the level it would have with a shorter cable.) Note that the idea of lower gain applies to the entire antenna system, which consists of the antenna, and matching devices or equipment (such as an antenna tuner), and the feedline used to connect the equipment to the antenna proper.

Second, unless we connect the equipment directly to the antenna wire, we shall have to use some length of transmission line to convey energy to and from the equipment and the antenna. In some cases, the recommended long line may represent the line length that we would have to use under any conditions. In such a case, the line losses are simply part of the cost of doing communications business. However, if the distance between the equipment and the antenna is less than the recommended long cable length, we are trading energy for SWR bandwidth.

Our goal is not to determine if we would be making a fair trade. Instead, we want to discover how much we gain and how much we lose on both sides of the trade. Even that answer is not quite simple, because we find more than one variable in the equation. One such variable is the length of the line. A second variable is the basic loss of the line. There are many coaxial cables, each with its own loss specifications, which increase as we increase the operating frequency.

Therefore, we have a small project. First, we need to find an antenna that works with coaxial cable (50 Ω by usual amateur practice) over several amateur HF bands. Second, we need to set up a standard length and see how the use of different types of coaxial cables may affect the results in terms both of system gain and SWR bandwidth. Finally, we need to survey for at least a couple of contrasting cables the effects of changing the cable length. By compiling some tables, graphs, and galleries of antenna patterns, we can make all of the necessary comparisons that will give us some insight into the terms of trading antenna system gain for increased SWR bandwidth.

Our Antenna: an Isolated Off-Center-Fed Wire

We shall select an antenna based on both its potentials and its limitations. If the subject antenna was perfect, we could not use it very well in showing any gains that a longer cable might give us. However, if the antenna had too many imperfections, no cable length could seemingly cure them. The design that we shall use is an isolated off-center-fed (OCF) antenna that we shall place 50' above average ground for all our modeling investigations. (A standard height and ground quality reduces the number of variables with which we shall have to contend.) **Fig. 1** outlines the antenna, along with some of the conventions used to describe it.

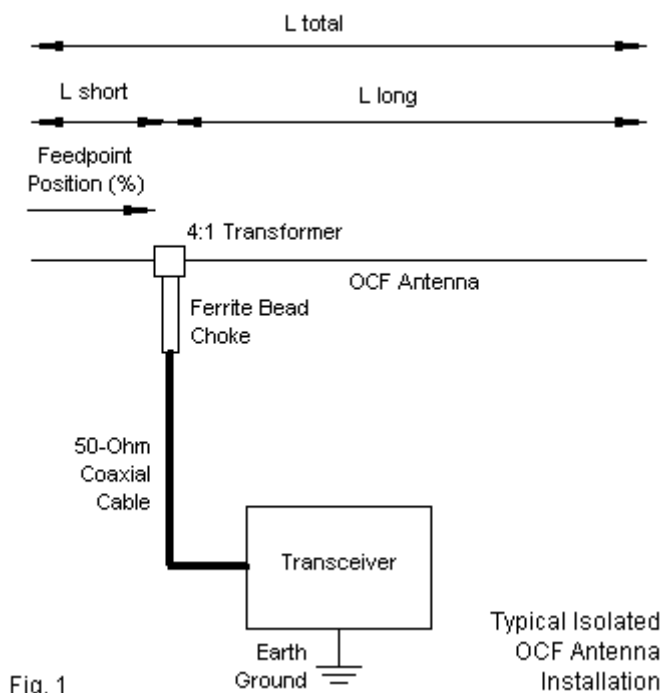

The antenna shown uses AWG #14 bare copper wire about 137.44' long overall (L total). The short end is 27.83' long (L short), while the long end is 109.61' (L long). We usually specify the wire's feedpoint position as a percentage of the total length inward from the short end of the element. In this case, the feedpoint position is 20.25%. At 3.5 MHz, the wire's feedpoint impedance, prior to any impedance transformation, is just about 200 Ω resistive. Since we want to work with a 50- Ω feedline, we need a 4:1 impedance transformer at the wire's feedpoint. A current balun is a convenient device, since it not only provides the required impedance transformation, but also transforms the balanced antenna to a non-balanced or single-ended condition for use with coaxial cable.

However, the antenna is truly balanced only at the center of the wire, where the current on each side of a gap that we might create is perfectly equal in magnitude and phase angle. When we move the gap away from the wire's center, the currents on either side of the gap are no longer equal. While good current baluns may result in equal current values on the coax center conductor and the inside of the braid, there may be some variation. The result will be radiation currents that appear on the outside of the braid. To attenuate any remnant radiation currents, we shall add a ferrite bead choke at the balun terminals. Since we expect the impedance at the balun terminals that join with the choke to be close to 50 Ω , the system can be very effective in

isolating all radiation currents to the horizontal wire itself. Hence, we obtain the idea of an isolated OCF antenna. For further information on the behavior of isolated OCFs, see “The Isolated Off-Center-Fed Antenna: Some Less-Explored Facets” at this web site: <http://www.cebik.com/wire/iocf.pdf>.

The antenna that we have just described is handy for our purposes—although I am not necessarily recommending it, since that action falls outside the scope of our work. The IOCF provides operating windows on numerous, but not all, HF amateur bands, namely, 80, 40, 20, 15, 12, and 10 meters. Let’s begin by ignoring the coaxial cable and see what sort of performance we would obtain if we could connect our equipment directly to the transformer. (Leaving the transformer in place allows us to use a 50-Ω standard for SWR sweeps both before and after we introduce the coaxial cable.) If we perform a very wide frequency sweep between 3.5 and 30 MHz (in 0.1-MHz steps), we can find the operating “windows,” that is frequency regions with a low SWR value relative to 50 Ω. **Fig. 2** shows the sweep with the specified OCF and impedance transformer at 50’ above average ground.

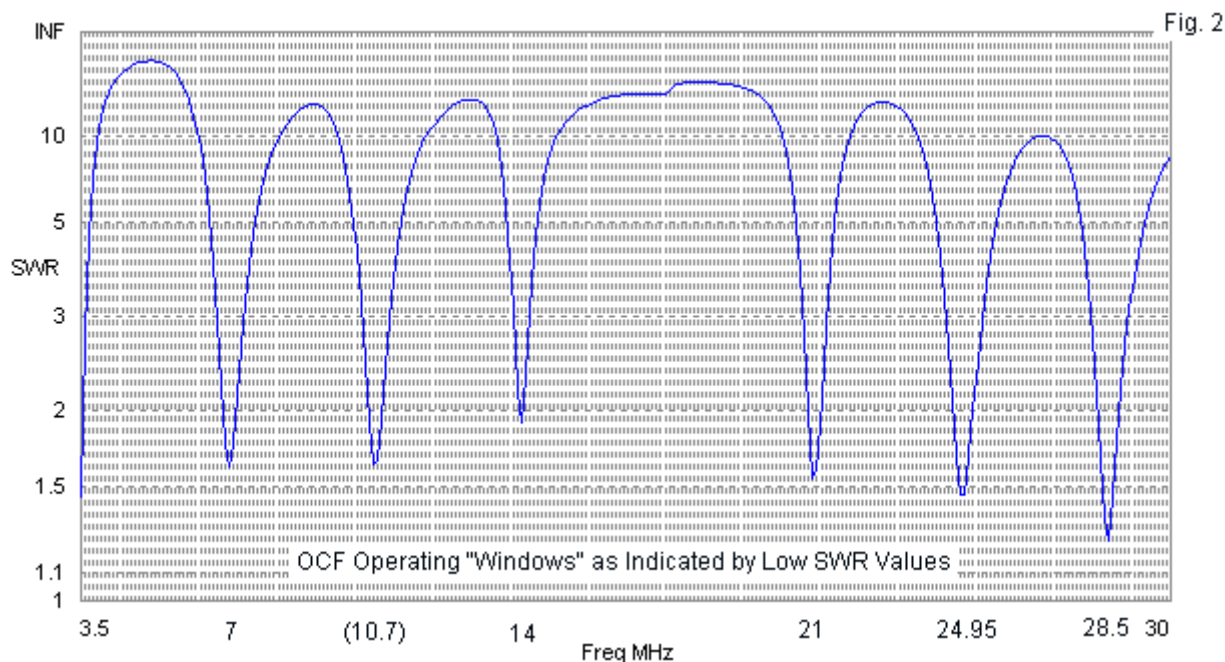

I have added markers on the frequency line to indicate potential operating windows. Six of them fall within amateur bands. Unfortunately, the window at 10.7 MHz is too high to allow use of the antenna on 30 meters. We should also note that each of the operating windows is fairly narrow. Some of them may not be wide enough or reach SWR values low enough to let us use the entire band as we measure such values at the impedance transformer.

Table 1 provides some representative information about the antenna on the amateur bands, using the approximate center frequency for each band except 80 meters. An inherent limitation of the antenna is that in order to achieve upper-band windows that fall within amateur bands, 80-meter operation, as defined by the SWR window, is confined to the lowest portion of the band.

The table shows a number of interesting values. The maximum gain in dBi is the strength of the strongest lobe. All patterns show two identical strong lobes, so the value applies to both of

them. The TO angle is the elevation angle of maximum gain. This value shows a continuous decrease in value as we raise the operating frequency, since the height of the antenna as measured in fractions of a wavelength at the operating frequency steadily increases. The azimuth angle indicates the heading of the strongest lobe relative to the wire ends, so that a value of 90° would indicate a direction exactly broadside to the wire. As a reference to a gallery of representative patterns (in **Fig. 3** ahead), the table lists the total number of lobes or gain maximum points in the azimuth pattern. The next entry is the feedpoint impedance at the impedance transformer terminals at the listed frequency. It will, of course, vary across each of the amateur bands.

The final number is the antenna efficiency. It is a measure of all losses in the antenna system, but does not include ground losses that may affect the ultimate effectiveness of the antenna. However, since all of the antennas will be at the same height above the same quality ground, those factors are constant. The antenna efficiency includes the losses from the wire itself, since copper is a good but not perfect conductor and its finite diameter subjects it to skin-effect losses. Also included are losses from any network in the antenna system. Our initial values include only the transformer, which by modeling limitation is nearly lossless. Network losses in subsequent tables will include those resulting from adding various types and lengths of coaxial cable to the antenna system. We shall be interested in comparing those later efficiency values to the ones in **Table 1**.

Table 1. Basic performance values for an isolated OCF with only impedance transformation

Freq. MHz	Max. Gain dBi	TO Angle degrees	Az Angle degrees	No. Lobes	Impedance R +/- jX Ω	Efficiency %
3.5	6.48	86	90	2	52.4 + j18.9	97.0
7.15	6.67	38	45	4	33.1 + j12.1	97.5
14.175	9.76	19	35	8	95.4 - j0.3	96.6
21.225	9.97	12	26	12	63.2 - 32.7	96.2
24.95	11.33	10	26	14	35.5 + 3.7	96.0
28.5	11.95	9	25	16	41.0 + j3.0	96.0

Note that the efficiency is not exactly the same on all bands, since the AWG #14 wire is getting fatter as we raise the operating frequency. The skin effect calculation in NEC accounts for both the rising resistance of a thinner skin as we increase frequency and for the increasing wire diameter as a function of a wavelength at each frequency. Also note the fact that the transformed impedance values show a wide variation both above and below the 50-Ω reference value. Multiply these values by 4 to arrive at the pre-transformer impedance values.

As expected, the TO angle decreases with increasing operating frequencies. On 80 meters, 50' is a very small fraction of a wavelength, and most of the energy appears at very high elevation angles. Above 80 meters, we find lower TO angles that tend to favor longer-range communication. As we increase the operating frequency, we also find that the maximum gain value increase, as does the number of lobes in the pattern. **Fig. 3** presents a gallery of elevation and azimuth patterns for the basic antenna and impedance transformer. The azimuth patterns more closely resemble those we would obtain from an end-fed wire (sometimes called an end-fed Zepp) than they do the patterns that would result from a ½-λ dipole used as a multi-band doublet. The patterns are dependent not only on the basic length of the wire element, but also on the exact placement of the feedpoint (in this instance, the impedance transformer) along the wire. For example, if the design had placed the feedpoint closer to center or farther from center, the 15-meter pattern would radically change.

Fig. 3

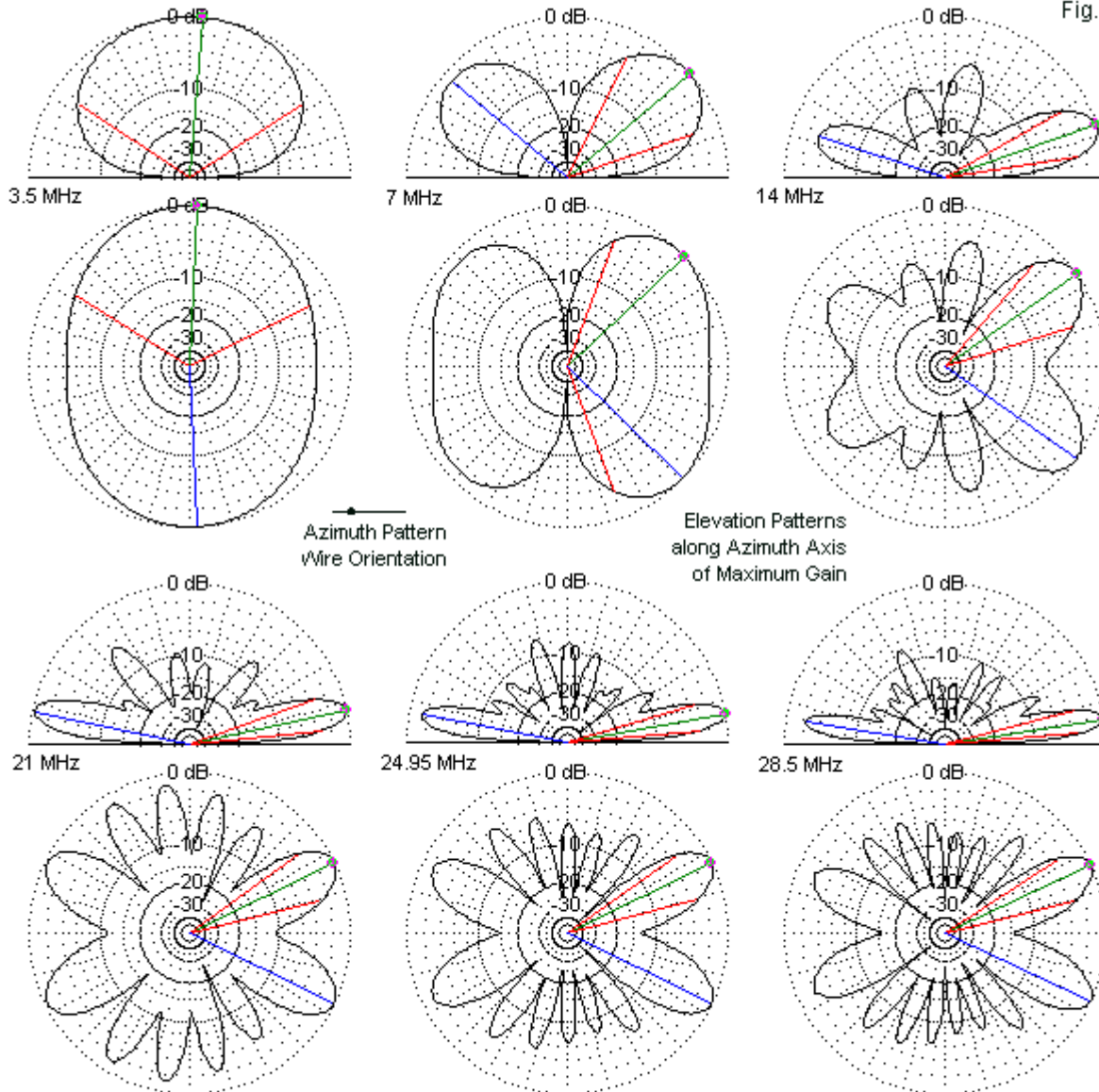

Elevation and Azimuth Patterns: Isolated OCF at 50' above Average Ground

Because the 80-meter azimuth pattern would show only a circle with a TO angle of 86° , the gallery uses an arbitrary 45° elevation angle to give a proper sense of the pattern shape. On all other bands, the azimuth patterns use the TO angle. The elevation patterns are taken along the axis created by a line from the azimuth angle of maximum radiation through the plot center. Any potential user of an OCF antenna should note the fact that as we raise the operating frequency, strong radiation (and reception sensitivity) quickly moves from broadside to the wire toward the ends of the wire, especially the longer end.

As we add coaxial cable feedlines to the antenna system between the impedance transformer and the equipment, the basic pattern shapes will not change. They result from the operating frequency and the antenna wire element itself. The numbers that we tally will show changes in the maximum gain. We should read these numbers as indicators of proportional

changes to the size of every lobe in a given pattern. TO and azimuth angles of maximum gain, along with the direction and relative strength of each pattern lobe will remain constant.

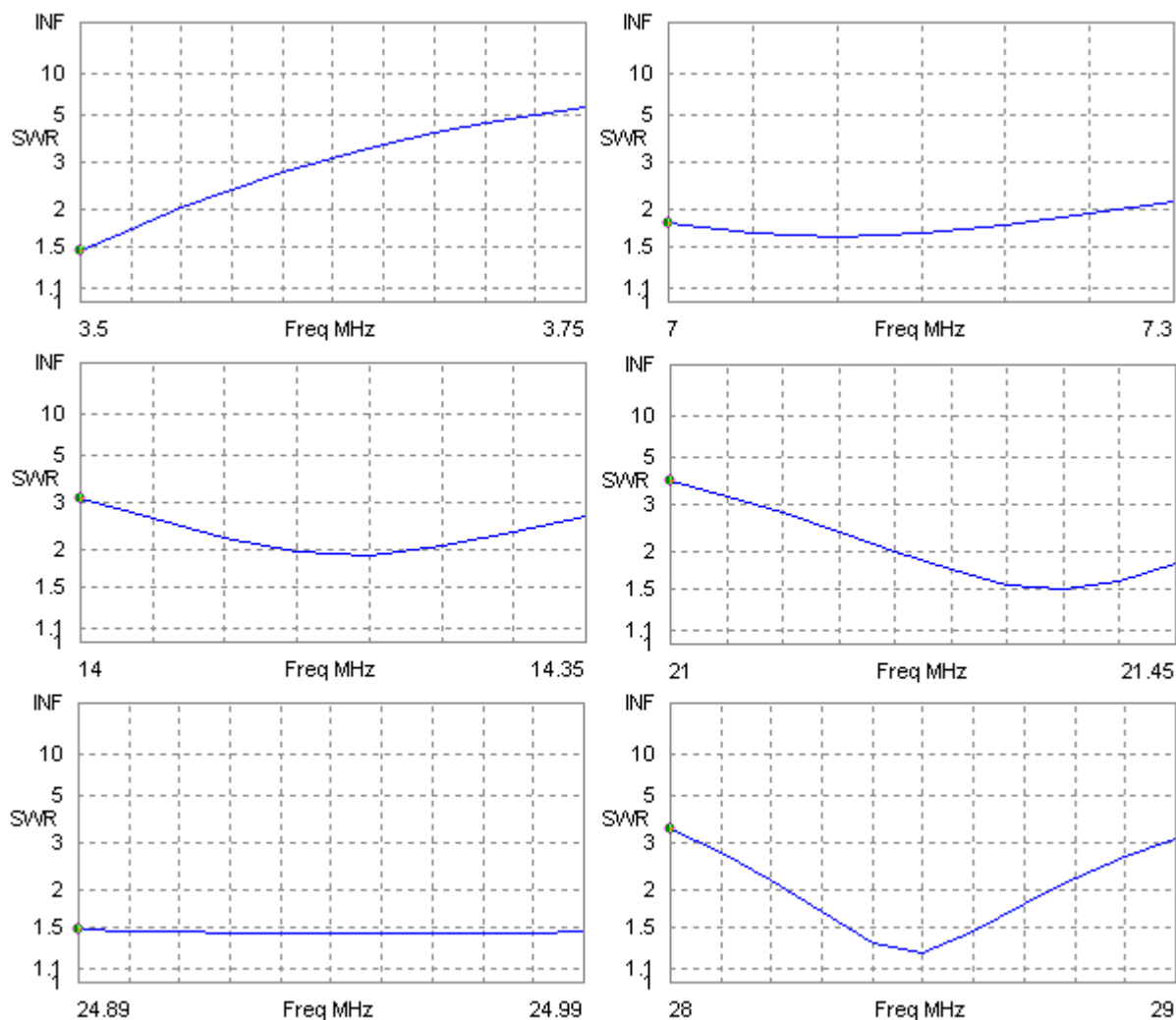

In-Band 50-Ohm SWR Sweeps: OCF Antenna 50' above Average Ground

Fig. 4

As we add coaxial cables to the OCF, we should expect to see changes in the in-band SWR sweeps that appear in **Fig. 4**. We noted that the operating windows of the sample isolated OCF are relatively narrow. If we use a 50-Ω SWR of 2:1 as the limit, the basic SWR sweeps show some very marginal cases. Even increasing the limit to 3:1 does not give us full band coverage on all bands. If we use an automatic antenna tuner—either inside or outside the transceiver case—we can effectively operate across all but 80 meters. However, this situation presumes that we can connect the transceiver directly to the impedance transformer 50' in the air. Much more common is the use of at least some length of coaxial cable between the impedance transformer and equipment that is much closer to the ground.

Let's explore the effects of adding coaxial cable in two steps. First, we shall use a standard length of cable and vary the type of cable that we use. Then we shall check the effects of varying the length of at least two samples of the cables we examine at the standard length. Together, the steps will give us a fairly complete picture of cable effects on the antenna system.

Many Cables, but One Length

We must use some sort of transmission line between the impedance transformer and the transmitting/receiving equipment. Since we have set up the antenna for a 50-Ω impedance, we may use one of the many coaxial cables available on the market. For our exploration, we shall use 4 quite different cables. The cheapest, lightest, and most readily available is RG-58A. Almost as light is RG-8X, which has significantly less loss than RG-58A. Both of these cables have jacket diameters in the 0.2" to 0.3" range. A fatter cable (0.4" outer diameter) is the standard RG-213, the replacement for RG-8 of World War II fame. The improved braid coverage reduced losses. To sample modern very low loss cables, I selected LMR500 from among current offerings. It has a jacket diameter of about 0.5". **Table 2** lists the cable, along with their velocity factor values and their losses per 100' at 10 MHz, a standard specification sheet listing. Fortunately, the NEC software that I am using allows me to include the line velocity factor and loss value in the program input.

Table 2. Coaxial cables used in subsequent notes

Cable Type	Nominal Impedance	Velocity Factor	Loss/100; @ 10 MHz
RG-59A	50	0.78	1.3
RG-8X	50	0.82	0.9
RG-213	50	0.66	0.6
LMR500	50	0.85	0.3

Note: Values taken from *The ARRL Antenna Book*.

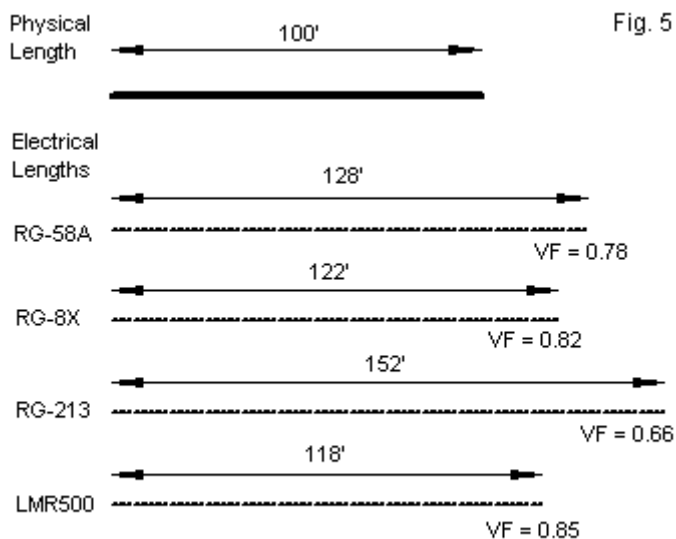

Transmission Line: Physical vs. Electrical Lengths

We shall work with a constant length in this part of our journey. However, we have to decide which of two lengths we shall use. As shown in **Fig. 5**, if we use 100 physical feet of cable, we end up with very different electrical lengths for the selected cable. The electrical length of a cable is its physical length divided by the velocity factor. Conversely, the required physical length of a cable for a specified electrical length will be the velocity factor times the electrical length.

In fact, we shall look at the cable in both ways. We are interested in two different aspects of the total antenna system, including its cable. One facet includes the feedpoint impedance at the equipment end of the cable and the differences we obtain for in-band SWR curves using the various cables. For comparable results among cables, the feedpoint impedance will be a function of the electrical length of the cable. Therefore, we shall examine impedance and SWR questions using 100 electrical feet of cable.

We are also interested in the effects of cable losses on the overall system gain and efficiency as calculated for the equipment end of the of the feedline. Cable losses are a function of the physical length of the cable. Therefore, we shall use for that part of our comparisons 100 physical feet of cable.

We shall begin by exploring the differences among the cables relative to the feedpoint impedance and the resulting in-band SWR curves. **Table 3** provides some numerical data that we may directly compare internally and with the impedance data in **Table 1** for the antenna and impedance transformer with no cable attached. The frequencies listed are the same in both tables. The cable columns appear in the order from the most to the least lossy lines. Below the impedance information is some reference data on the maximum gain of each full antenna system. Each system differs only in the cable connected to the unchanging antenna and impedance transformer.

Table 3. OCF feedpoint impedance and maximum gain using 100' *electrical* lengths of specified coaxial cables

Freq. MHz	Impedance				
	RG-58A	RG-8X	RG-213	LMR500	
3.5	35.3 – j0.5	35.1 – j0.1	34.9 + j0.3	34.8 + j0.5	
7.15	70.3 – j16.6	71.6 – j16.9	73.3 – j17.5	74.1 – j17.7	
14.175	66.7 + j21.7	67.9 + j24.3	69.4 + j28.0	70.0 + j29.7	
21.225	32.9 – j4.2	31.5 – j4.2	29.6 – j4.3	28.8 – j4.4	
24.95	41.6 + j6.8	40.7 + j7.4	39.4 + j8.3	38.9 + j8.6	
28.5	45.3 – j5.6	44.9 – j6.0	44.3 – j6.6	44.1 – j6.9	

Freq. MHz	Maximum Gain				
	RG-58A	RG-8X	RG-213	LMR500	Δ Gain
3.5	5.89	6.05	6.25	6.33	0.44
7.15	5.77	6.01	6.31	6.44	0.67
14.175	8.33	8.71	9.19	9.39	1.06
21.225	8.27	8.72	9.29	9.52	1.25
24.95	9.65	10.10	10.67	10.90	1.25
28.5	10.22	10.69	11.27	11.51	1.29

If we use 50 +/- j0 Ω as a reference value, the impedance data shows that the higher the line losses, the closer that the listed feedpoint impedance approaches the reference value. Lines with lower loss values are farther removed from 50 Ω resistively and have higher values of either inductive or capacitive reactance. That is one critical piece of evidence to show the SWR broadening effects of higher line losses. (We may also sample the fact that as we use line losses to draw the impedance closer to 50 Ω, we also suffer increased antenna system gain losses. The table shows that gain goes up using a line with lower losses, and the improvement is greater at higher frequencies, as line losses increase for any cable with increasing operating frequencies. Compare the gain values with those in **Table 1.**)

The consequences of 100' cable losses for the SWR on each band covered by the isolated OCF appear in **Fig. 6**. Compare the coverage of each band at limits of 2:1 and 3:1 with the curves in **Fig. 4**, which provides SWR sweeps with only the antenna and its impedance transformer. (We would obtain the same curves shown in **Fig. 4** if we provided the model with 100' of hypothetically lossless cable.)

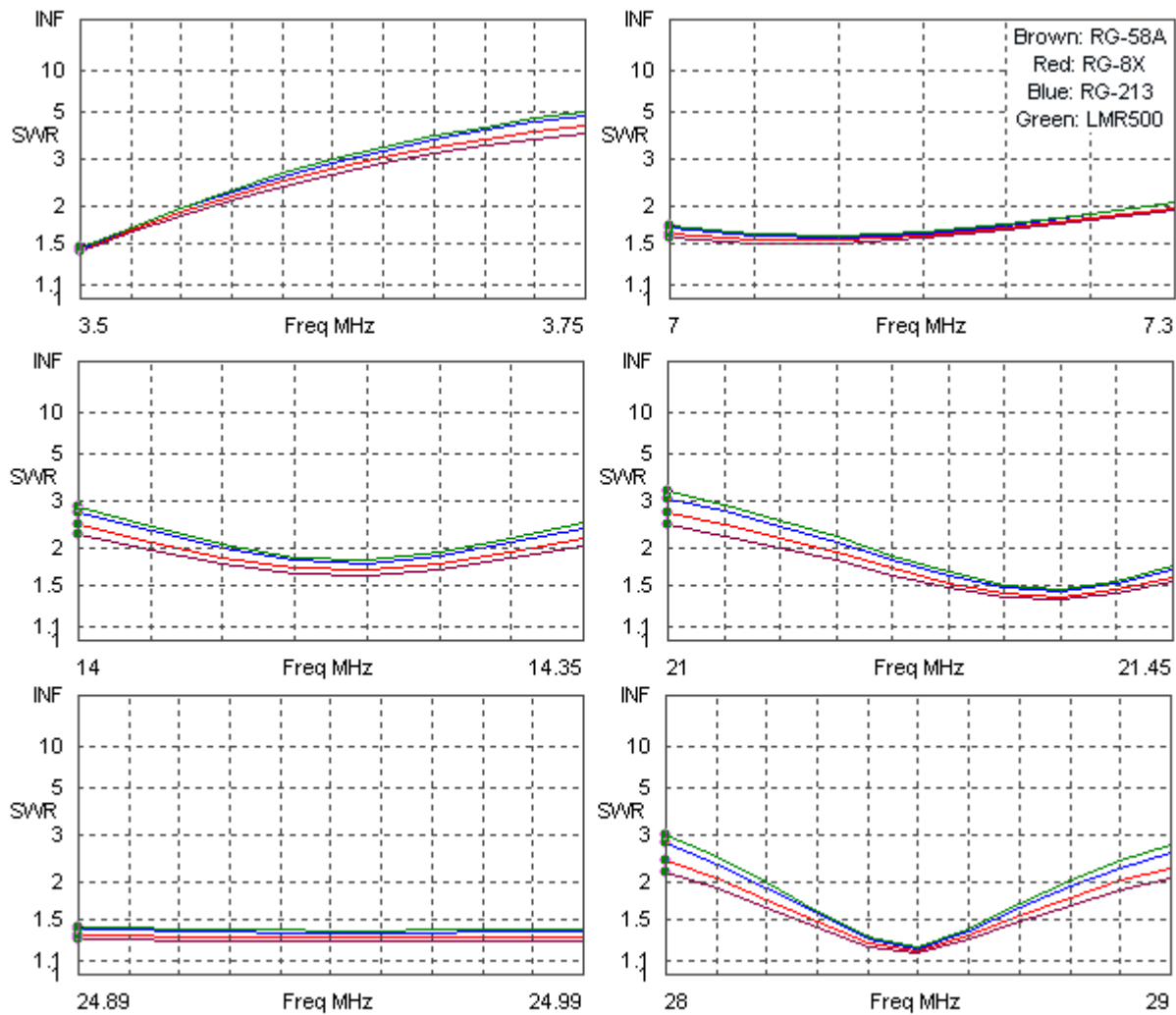

In-Band 50-Ohm SWR Sweeps: OCF Antenna and Cables 50' above Average Ground Fig. 6

In terms of SWR bandwidth coverage, the difference among the cables is least where the SWR is low from the start. For example, 12 meters shows parallel, nearly overlapping lines. As well, the differences are less among cables with difference loss levels at lower frequencies, for example, 40 meters. As the frequency increases and as the baseline SWR value increases at the antenna, lossier cables begin to show their bandwidth-spreading properties. For example, RG-58A on 10 meters allows nearly complete band coverage at the 2:1 level, while the low-loss LMR500 requires a 3:1 SWR limit for full band coverage. The 50-Ω SWR sweeps provide the second critical piece of evidence about the bandwidth broadening effects of using lossier cables. However, we should not evaluate the effects of significant cable runs solely on the basis of SWR.

To evaluate the various cables, we should also examine the resulting antenna system gain and efficiency. For this evaluation, we shall use 100 physical feet of cable, since losses are a function of the cable's physical length. **Table 4** provides the relevant numbers. Remember that the total system efficiency includes not only cable losses, but also losses due to the wire resistivity at each frequency. As shown in **Table 1**, wire losses are limited to between 3% and 4%, depending upon the frequency of operation. Since modeling restrictions create a lossless impedance transformer, the remaining deficit from 100% efficiency is due to losses in the cables.

Table 4. OCF maximum gain and system efficiency using 100' *physical* lengths of specified coaxial cables

Cables	RG-58A		RG-8X		RG-213		LMR500	
	Gain dBi	Eff. %	Gain dBi	Eff. %	Gain dBi	Eff. %	Gain dBi	Eff. %
3.5	5.67	80.4	5.92	85.2	6.11	89.0	6.30	92.9
7.15	5.49	74.3	5.86	81.0	6.10	85.5	6.40	91.7
14.175	7.95	63.7	8.51	72.4	8.93	79.8	9.34	87.7
21.225	7.79	58.3	8.46	68.0	8.94	75.8	9.45	85.5
24.95	9.20	58.9	9.84	68.1	10.34	76.5	10.83	85.6
28.5	9.72	57.6	10.40	67.3	10.92	75.8	11.43	85.3

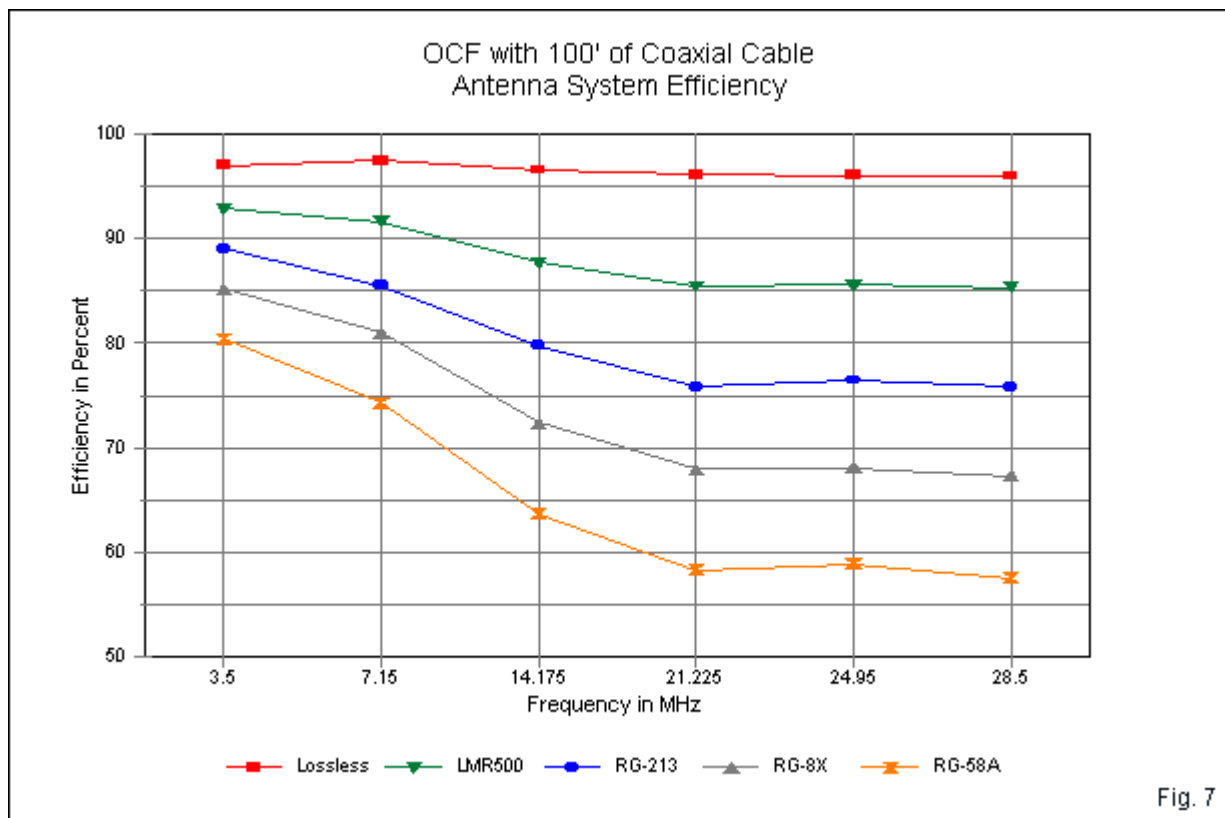

Fig. 7 graphs the efficiency levels for each cable and includes the values for the no cable situation, which is equivalent to using a hypothetical 100' cable with no losses at all. Besides variations in wire losses due to varying skin effects at the different frequencies, we see other fluctuations in the graphed lines. Cable losses are a combination of two factors. One is the

basic cable loss under conditions in which the cable's characteristic impedance equals the antenna terminal impedance. The second factor is the additional loss created by SWR values higher than 1:1. In the values for the OCF with 100' of each type of cable, we can see that the 15-meter mid-band SWR is somewhat higher than the mid-band SWR on 12 meters. The difference, while not exceptionally great, is sufficient to show up as a slightly higher efficiency overall on 12 meters than on 15 meters.

The efficiency graph provides the following information: for each cable at the specified length and for each operating frequency, the efficiency value permits the user to estimate with reasonably good accuracy how much of the power developed by a transmitter actually shows up as radiation from the antenna system. A 50% efficiency would mean that half the power is lost as heat, resulting in a 3-dB reduction in overall antenna system gain and an equivalent reduction in received signal strength. However, this figure alone is not very informative, since we normally must use one cable or another with enough length to reach from the antenna to the equipment. Hence, the value of the data lies in comparing one cable to another, balancing the desire for full-band coverage with the desire for maximum signal input to the equipment and maximum signal output from the antenna system.

Samples of Single Cable Types with Variable Lengths

100' of even the lossiest cable of the group (RG-58A) failed to provide a 2:1 50-Ω SWR on all bands covered by the modeled isolated OCF antenna. It may be useful to examine the effects of cable length on both SWR bandwidth coverage and antenna system overall efficiency in order to see if full coverage under the stringent SWR limitation is possible. To simplify our survey, we shall explore only two cables: the least lossy (LMR500) and the most lossy (RG-58A). You may interpolate the other two cable values from the values that emerge from examining the extreme cases. For purposes of comparison, we shall look at 4 physical lengths of cable: 50', 100', 150', and 200', as suggested in **Fig. 8**. Besides examining numerical data at the mid-band frequencies, we shall compare both SWR and efficiency graphs.

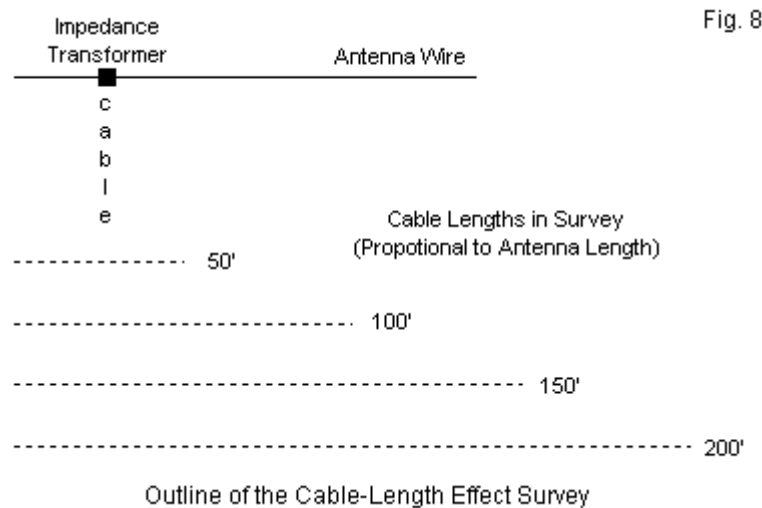

1. *LMR500*: Our least lossy cable loses 0.3 dB per 100' of cable at 10 MHz when perfectly matched. Of course, the loss is less at frequencies below 10 MHz and greater at frequencies above 10 MHz. How much the losses differ by frequency for each length of cable appears in

Table 5. The 200' case at 10 meters still shows an antenna system efficiency value above 75%, with only about 1 dB gain loss compared to a hypothetical lossless cable.

Table 5. OCF system maximum gain and system efficiency using various *physical* lengths of LMR500 coaxial cables

Cables	50'		100'		150'		200'	
Freq. MHz	Gain dBi	Eff. %	Gain dBi	Eff. %	Gain dBi	Eff. %	Gain dBi	Eff. %
3.5	6.41	95.5	6.30	92.9	6.22	91.2	6.12	89.2
7.15	6.53	94.6	6.40	91.7	6.26	88.9	6.11	85.8
14.175	9.53	91.7	9.34	87.7	9.13	83.5	8.91	79.4
21.225	9.69	90.3	9.45	85.5	9.19	80.4	8.95	76.2
24.95	11.08	90.7	10.83	85.6	10.58	80.9	10.33	76.4
28.5	11.69	90.5	11.43	85.3	11.17	80.3	10.92	75.8

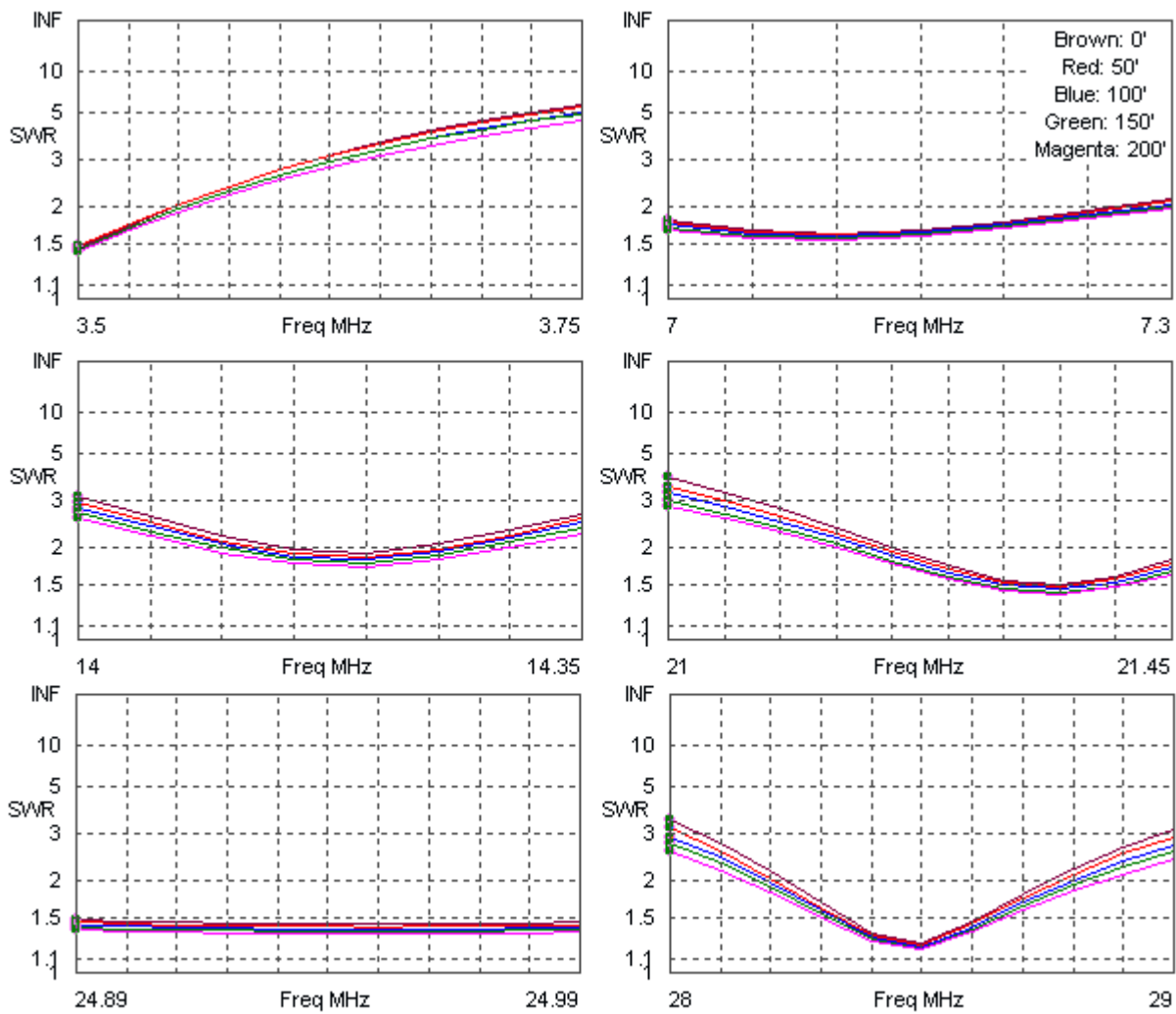

In-Band 50-Ohm SWR Sweeps: OCF Antenna and LMR500 Cable 50' above Average Ground

Fig. 9

Fig. 9 provides us with a view of the anticipated SWR bandwidth increases that result from using longer runs of the low-loss LMR500 cable (with the sweep for a hypothetical 0-length line added for reference). In fact, the matched losses (0.3 dB at 10 MHz) are so low that we gain very little in this department. The lower the initial SWR value relative to 50 Ω , the less that a long cable run will do to improve the bandwidth, as shown by the 12-meter curves. As well, even with significant SWR values, the losses are low enough at lower frequencies to obscure most of the differences. Even at 10 meters, the bandwidth improvement is marginal with the low-loss cable.

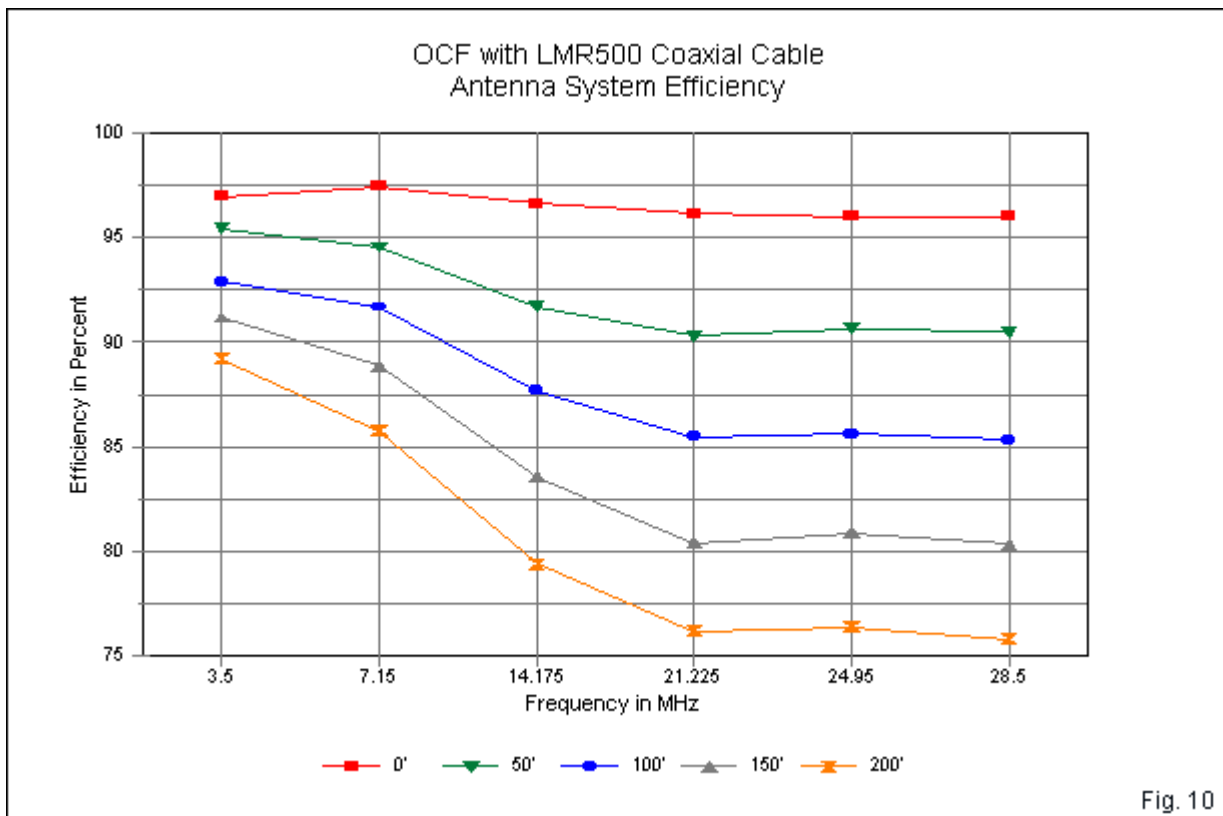

Fig. 10

Although we do not acquire useful amounts of SWR bandwidth, we do retain a relatively high level of efficiency from the overall antenna system (including the antenna, the impedance transformer, and the cable). Since the graph lines include losses from all sources (within the limits of the model), the lines are not perfectly congruent. As well, the steps are not exactly proportional to the steps in the survey of line lengths.

A very low-loss line, like LMR500, therefore is not a good choice for someone intent upon expanding the SWR bandwidth, as the SWR is measured at the equipment end of the line. It is a very good choice for maintaining maximum possible efficiency from the overall antenna system.

2. **RG-58A:** Of the cables in our survey, RG-58A is has the highest loss specification: 1.3 dB per 100' at 10 MHz when perfectly matched. Like all cables, the losses per unit length are lower for frequencies under 10 MHz and higher for frequencies above the specified 10 MHz. If we cover the same set of variables with the lighter and cheaper cable, we obtain similar patterns of results, but with very different numerical values. **Table 6** provides data on the overall antenna system gain and the efficiency of the system with RG-58A.

Table 6. OCF system maximum gain and system efficiency using various *physical* lengths of RG-58A coaxial cables

Cables	50'		100'		150'		200'	
Freq. MHz	Gain dBi	Eff. %	Gain dBi	Eff. %	Gain dBi	Eff. %	Gain dBi	Eff. %
3.5	6.17	90.3	5.67	80.4	5.35	74.6	4.88	67.1
7.15	6.07	85.0	5.49	74.3	4.91	65.1	4.34	57.0
14.175	8.82	77.8	7.95	63.7	7.13	52.8	6.33	43.9
21.225	8.84	74.1	7.79	58.3	6.82	46.6	5.84	37.2
24.95	10.24	74.8	9.20	58.9	8.16	46.3	7.11	36.3
28.5	10.84	74.4	9.72	57.6	8.62	44.6	7.52	34.7

The SWR bandwidth effects of using RG-58A become readily apparent in the 50-Ω SWR sweeps in **Fig. 11**. The first visual effect is our ability to separate virtually every line in every sweep. Longer runs of the cable provide additional usable SWR bandwidth on virtually every band (excluding 12 meters, of course).

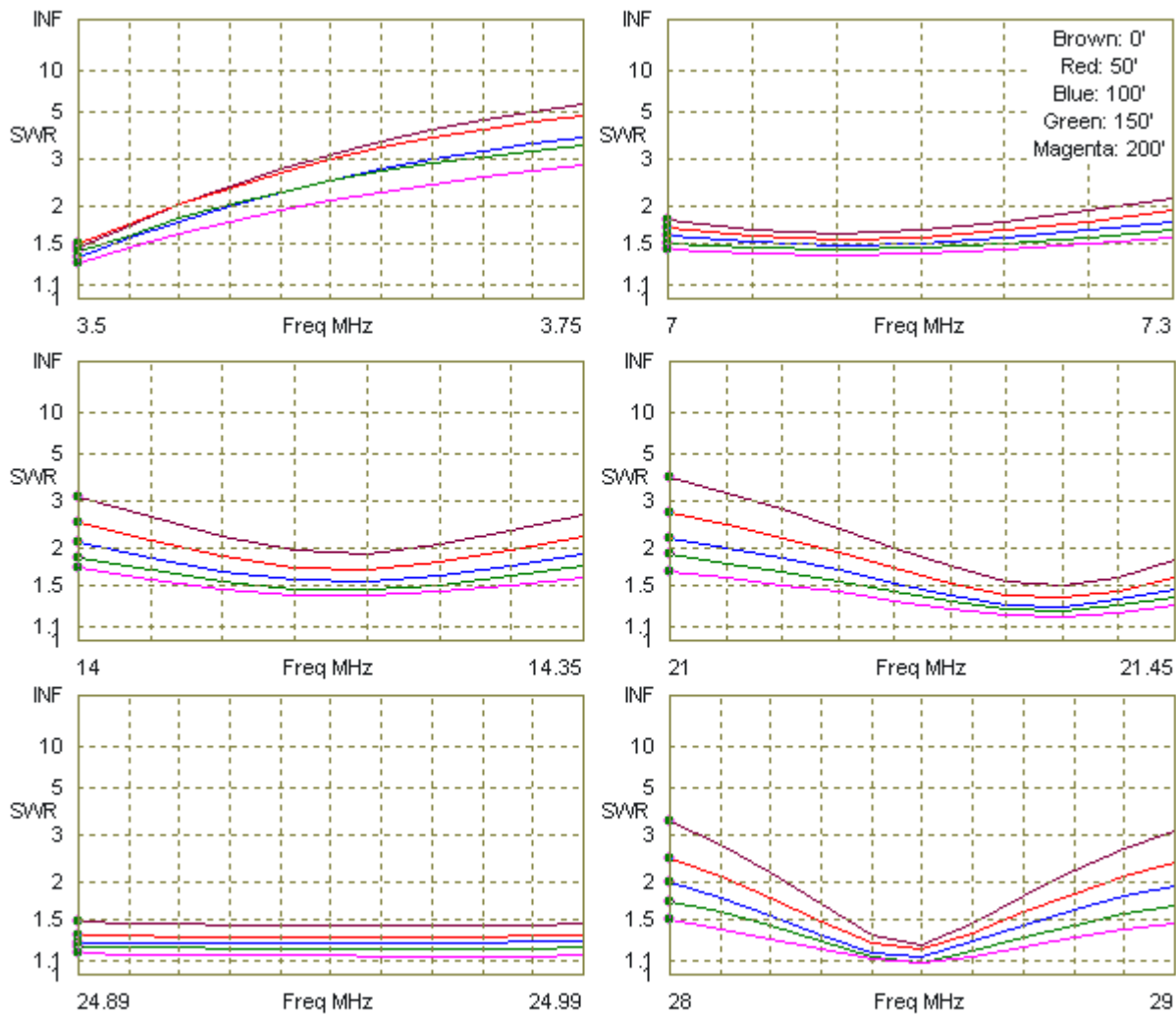

In-Band 50-Ohm SWR Sweeps: OCF Antenna and RG-58A Cable 50' above Average Ground

Fig. 11

150' of RG-58A allows use of all of the bands above 80 meters even under the more rigorous 2:1 limitation. As we increase the operating frequency, the flattening of the SWR curve becomes ever more dramatic, for instance, on 10 meters. Even 80 meters shows a doubled operating bandwidth with the use of 200' of RG-58A.

The SWR sweeps results from the losses in the cable, which have the effect of transforming the impedance at the antenna end of the line to values closer to the line's characteristic impedance at the equipment end of the feed system. However, as both the table and **Fig. 12** reveal, the antenna system gain and efficiency suffer greatly. 200' of RG-58A costs about 1.6 dB of system gain at 80 meters, a value that increases to over 4.4 dB on 10 meters. 4.4 dB amounts to between 70% and 80% of an S-unit, depending upon the receiver's calibration.

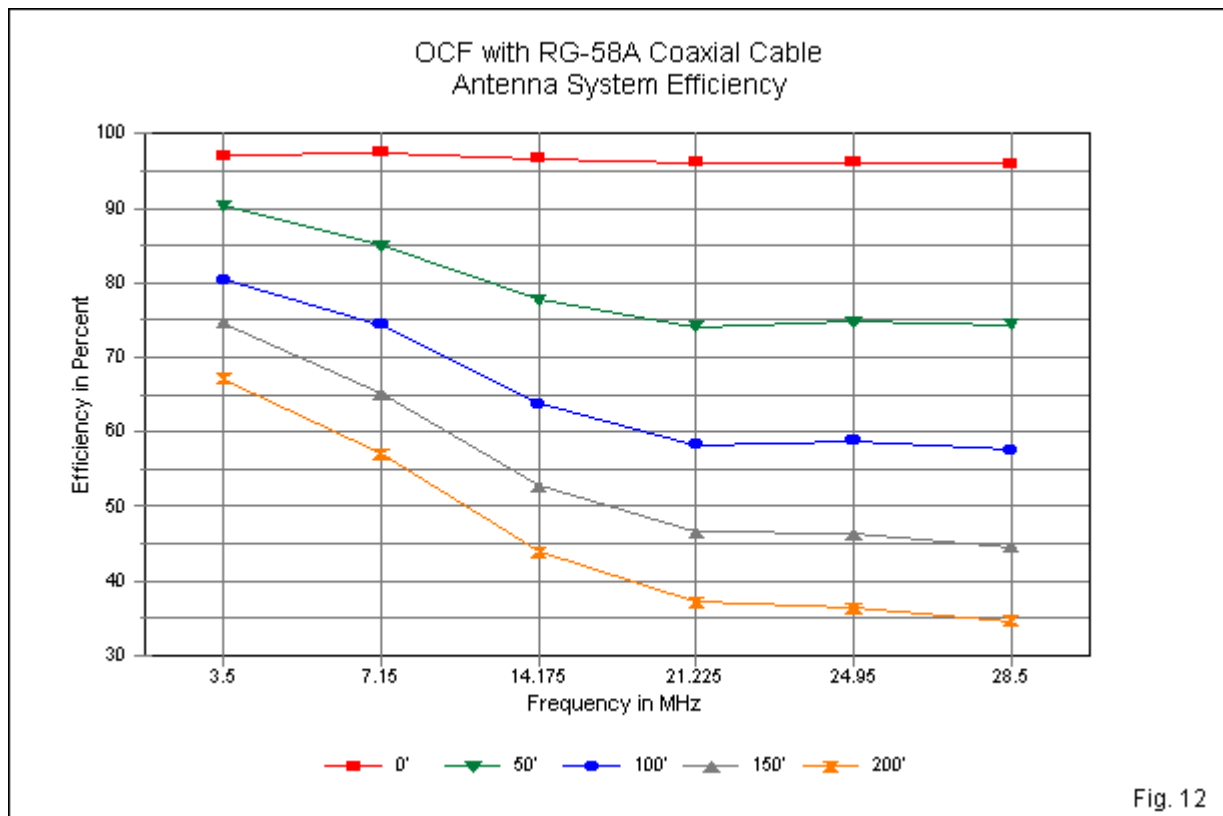

Fig. 12

The efficiency curves for RG-8A have a superficial resemblance to those for LMR500 in terms of the progression of efficiency decreases as we raise the operating frequency. However, the LMR500 curve Y-axis lowest value is 75%. For RG-58A, the lowest value on the Y-axis of the graph is 30%. Nothing has changed relative to the antenna itself or the impedance transformer. The decreases in efficiency—and the additional energy converted to heat instead of radiation—are solely due to the much higher losses in the lighter and cheaper cable.

Conclusion

The goal of our exercise has been to demonstrate the interrelationship between SWR bandwidth and efficiency losses as we select both the cable that we use and the length of that cable between the antenna and the equipment. We employed a version of the isolated off-center-fed element as our vehicle, since it shows some interesting SWR curves on the higher bands. We discovered two routes to increasing the SWR bandwidth: the use of longer cables

and the use of cables with higher inherent losses due to their construction. RG-213 and RG-8X would have efficiency and bandwidth results between those shown for LMR500 and RG-58A.

Assuming that we have selected the OCF antenna placed 50' above average ground, we are faced with a choice: higher efficiency or full coverage of all of the included bands. Since LMR500 and RG-213 are heavier cables and may create some mechanical challenges for long-term durability, we are likely to select one of the lighter cables. However, we need not go all the way to the very lossy RG-58A (or the same cable with any other suffix letter) to obtain full coverage. We might successfully use RG-8X if we have an antenna tuner built into the transceiver or have an external unit. In most cases, the SWR values are not high enough to create significant tuner losses at the level of difference between RG-8X and RG-58. A tuner might also allow us to operate the entire lower half of 80 meters (up to 3.75 MHz) with acceptable losses, even though we are using coaxial cable as our feedline.

The final choices belong to the antenna user. Our goal has been to explore the trade-offs involved in those choices in sufficient depth—but without heavy doses of hand calculation—to allow you to gain some insight into the scope of what is involved as cable losses increase SWR bandwidth and lower efficiency of the total antenna system. Some loss will always be involved as long as we need any cable at all. How much added loss you may be willing to absorb to increase the operating bandwidth on the amateur bands is a personal decision based on your operating goals.

Appendix: More Coax vs. an Antenna Tuner

At the end of our basic discussion of the effects of coaxial cable on both antenna system efficiency and SWR bandwidth, I suggested an alternative strategy to adding coaxial cable to a system to widen the operating bandwidth. The suggestion was the use of an antenna tuner, such as those included within many modern transceivers or perhaps a manual or automatic external unit. Perhaps we should perform at least one comparison to see the relative consequence of each option.

To form a fair test, let's use the isolated OCF antenna of the main text, which includes at least some coverage of 80, 40, 20, 15, 12, and 10 meters. Composed of AWG #14 copper wire, the antenna is 50' above average ground. Let's also specify that we need at least 100' of coaxial cable to complete the run between the impedance transformer and the station equipment. The most likely cable to use for this system is RG-8X, which is fairly light, easy to handle, and less lossy than the cheaper RG-58A. RG-8X has a specified matched loss of 0.9 dB per 100' at 10 MHz, where matched loss is the loss before adding in additional losses that result from the SWR.

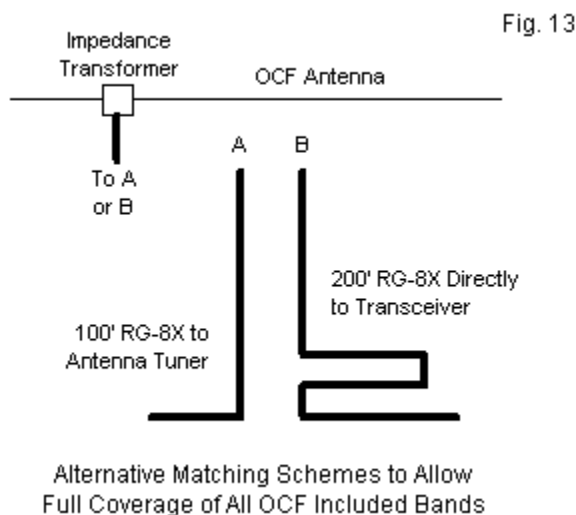

Fig. 13 shows the options that we have. We may run the 100' of cable to an antenna tuner to obtain a quite precise 50- Ω impedance at all operating frequencies. Alternatively, we may use 200' of RG-8X directly to the transceiver and still obtain full band coverage of all included operating segments. The SWR will not be 1:1 at every frequency, but it will be less than 2:1 across every included band.

Our interest in these alternatives is simple: since either alternative gives us the required SWR bandwidth, which one offers the higher efficiency? Higher efficiency, of course, results in a higher overall antenna system gain, but the difference between systems must be quite significant before we would notice the difference operationally. I note this last fact because the decision is likely to rest on a cluster of factors, including cost. Adding an antenna tuner to a rig or adding an external unit is usually more expensive than adding a coil of coax in the corner of the operating room. To justify the cost, the difference in efficiency should be considerable.

The use of 200' of RG-8X presents the easier case to evaluate, since we may derive antenna system efficiency values and other data directly from some NEC software. We can

tabulate the data by looking at the band edge information on the isolated OCF plus the feedline rather than looking at a mid-band value. The SWR curves for each band, as shown in **Fig. 4**, have their highest values at the band edges, often with differences between the two limiting frequencies. 80 meters is the exception, since the antenna design rests on setting 3.5 MHz as the fundamental resonant frequency. For our purposes, we shall define 80 meters as extending from 3.5 to 3.75 MHz. The data for a cable length of 200' appears in **Table 7**.

Table 7. Impedance and efficiency values of the OCF with 200' of RG-8X coaxial cable

Band Meters	Freq. MHz	50-Ω SWR	Impedance R +/- jX Ω	Efficiency %
80	3.5	1.35	37.1 + j1.5	75.3
	3.75	3.28	34.7 + j50.2	53.8
40	7.0	1.47	68.7 + j13.1	65.7
	7.3	1.72	32.7 - j13.8	64.7
20	14.0	1.92	95.2 - j6.1	48.0
	14.35	1.78	86.6 - j11.3	51.1
15	21.0	1.92	26.7 + j6.6	38.6
	21.45	1.36	37.9 + j6.0	49.3
12	24.89	1.21	53.1 + j9.2	48.5
	24.99	1.21	60.5 - j0.5	48.8
10	28.0	1.76	82.6 - j17.0	35.8
	29.0	1.71	48.2 - j26.4	37.9

The lower band edge SWR values above 1.9:1 confirm that we need the full 200' of RG-8X to achieve our goal. Of course, the upper end of the defined 80-meter band does not achieve the desired 50-Ω SWR values, although the value is much lower than with a shorter cable. One casualty of the system is the lowering of the efficiency on 12 meters, where the initial SWR values were well below 2:1 without any cable at all. Nevertheless, using 200' of RG-8X will achieve almost all of the operating goals that we set for the antenna system.

The alternative system of using 100' of coax as the minimum length necessary to connect the antenna to the station along with an antenna tuner requires a two-step calculating process. First, we must calculate the efficiency of the system before we add in the antenna tuner. Except for the length of the line, the process is identical to the one we used for 200' of cable. **Table 8** provides the data. The efficiency values will be provisional and subject to revision once we include the tuner in the second step of the process.

As well, the impedance values are not ones that will face the equipment. Rather, they will be the values at the output terminals of the antenna tuner. The tuner will transform these values to (nominally) 50 Ω resistive. The value of recording the impedance values at the equipment end of the 100' cable is to obtain a feel for the range of impedance values that the tuner must transform. In general, for any well designed tuner, the closer the values are to the input impedance (in this case 50 Ω), the higher will be the tuner's efficiency. This observation applies to both the transmitting condition, in which the transceiver is the source and the antenna system is the load, and the receiving condition, in which the antenna system is the source and the transceiver is the load.

The table clearly shows that with 100' of RG-8X, we cannot obtain less than 2:1 SWR across every band. Only 40 and 12 meters meet this requirement. You may usefully compare the band edge SWR values for both tables to see the difference that cable length alone makes.

Table 8. Impedance and efficiency values of the OCF with 100' of RG-8X coaxial cable

Band Meters	Freq. MHz	50-Ω SWR	Impedance R +/- jX Ω	Efficiency %
80	3.5	1.38	40.6 + j11.3	85.2
	3.75	4.25	51.8 + j78.3	69.6
40	7.0	1.63	55.1 – j25.5	80.2
	7.3	1.88	27.3 + j6.3	78.8
20	14.0	2.32	21.8 + j4.9	65.7
	14.35	2.11	23.9 – j3.6	69.2
15	21.0	2.52	24.0 – j20.5	57.9
	21.45	1.55	43.4 – j19.6	68.4
12	24.89	1.31	41.3 + j8.5	67.9
	24.99	1.29	52.8 + j12.9	68.1
10	28.0	2.28	76.6 – j45.1	55.3
	29.0	2.15	104.6 – j15.5	57.9

The impedance values are a greater distance from 50 Ω than the ones for the 200' cable, but the pattern is not consistent. Although the lines have a 2:1 length ratio considering both physical and electrical length, impedance values do not depend on length alone. The precise values are a function of where we measure along the line as a fraction of a half-wavelength. The 100' and 200' measuring positions on most bands intersect the half-wavelength curves at different points.

As a preliminary measure, the shorter cable shows an average efficiency improvement of 15% to 20%. The exception to this trend occurs at 3.5 MHz, where the low SWR reduces the short-cable improvement to about 10%. Subject to adjustment for tuner efficiency, the difference is significant.

Between the point at which we calculated the impedance and efficiency value and the equipment, we must insert an antenna tuner. Tuners come in many different designs, as suggested by the sketches in **Fig. 14**. All of the designs are single-ended and require no balun or other device between the network output and the cable from the antenna. The exercise presumes that the installation includes all proper methods of attenuating common-mode currents from the outside of the cable braid, as well as all proper grounding techniques to ensure a good RF ground and a good electrical safety ground. Since the coaxial cable between the antenna tuner and the transceiver will be very short, we may consider it to have no losses.

Of the choices among antenna tuner configurations, the CLC T-network tuner is the most common among commercial units. Some automatic tuners may use other network designs, but the CLC T is a very wide-range design capable of covering a large span of both resistive and reactive values at the terminals. In fact, the impedances that appear in **Table 8** will present the tuner with no significant challenges. For many bands, but not for all, the input or transceiver side capacitor may be set a maximum value. Because the impedance-matching challenge for the CLC T tuner is small, we may find various settings that will provide the necessary impedance match, especially if the tuner has a roller inductor. As well, the network or loaded Q of the tuner will be very low compared to the unloaded Q of the components—especially the inductor. This condition will generally provide quite broad tuning and relatively high efficiency from the unit.

The tuner and overall antenna system efficiency levels appear in **Table 9**. The tuner efficiency values are based on an inductor Q of 250. If you wish to use more modest efficiency values based on an inductor unloaded Q of 100, subtract about 2% from the listed values on 80 meters, 1% from the values on 40 meters, and proportionally less for each of the upper bands.

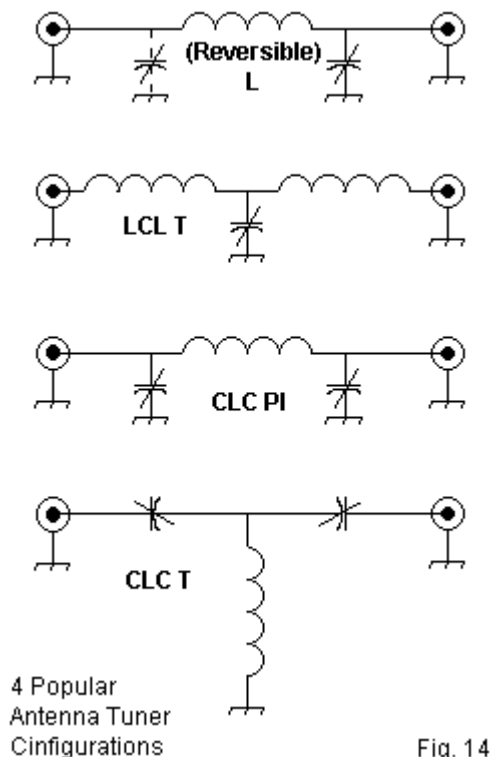

Fig. 14

Table 9. Calculated antenna tuner, antenna system, and complete system efficiency values for the OCF antenna installation (all values in %)

Band Meters	Freq. MHz	Tuner Efficiency	Antenna System Efficiency (Table 8)	Installation Efficiency %	(200' RG-8X)	(Δ)
80	3.5	98.4	85.2	83.8	75.3	8.5
	3.75	98.6	69.6	68.6	53.8	14.8
40	7.0	99.3	80.2	79.6	65.7	13.9
	7.3	99.0	78.8	78.0	64.7	13.3
20	14.0	99.2	65.7	65.2	48.0	17.2
	14.35	99.3	69.2	68.7	51.1	17.6
15	21.0	99.4	57.9	57.6	38.6	19.0
	21.45	99.6	68.6	68.3	49.3	19.0
12	24.89	99.6	67.9	67.6	48.5	19.1
	24.99	99.8	68.1	68.0	48.8	19.2
10	28.0	99.2	55.3	54.9	35.8	19.1
	29.0	99.4	57.9	57.6	37.9	19.7

The total installation efficiency is simply the product of the tuner efficiency and the antenna system efficiency values from **Table 8**. The reductions in tuner efficiency created by reducing

the presumed inductor Q to 100 have an effect that is greater than 1% only at 3.5 MHz. At all other frequencies, the effect is well under 1%.

We cannot avoid the continuing reduction in efficiency with a rising operating frequency. We had to install the 100' cable just to ensure that we could convey energy from the equipment to the antenna. However, we had a choice between using cable alone and a cable plus tuner system, and the final columns of **Table 9** show the advantages of using a tuner. You may correlate the minor fluctuations in the tabulated values for the overall tuner system installation with the band edge SWR values for each band as a supplementary exercise.

For our purposes, the use of a tuner shows its advantage in the Δ column of the table. Not only does the tuner provide higher overall system efficiency than the 200' cable run, it has added advantages. For example, we need not be quite so fussy with the antenna pruning process so long as all of the bands above 80 meters have SWR values less than 3:1. In addition, it is likely that we can stretch the 80-meter band to nearly full coverage at an acceptable efficiency level compared to the levels obtained on the highest bands.

Most commercially made tuners have additional losses outside the network, often from stray lead inductances and capacitance between the case and the components. These strays have the general effect of lowering the component Q values, especially on the upper bands, by a small amount (assuming a good design to begin with). However, it is unlikely that such added losses will make the system using the minimum cable length (100') and the tuner as lossy as using the 200' cable length.

If you use a very low-loss cable, such as LMR500, then the cable losses in the 100' length will decrease significantly. Tuner losses will rise a small amount because the impedances at the terminals will be more distant from the 50- Ω reference impedance. The reduced cable losses will offset the added tuner losses by a wide margin. Still, the low-loss cable will be much heavier than the convenient RG-8X.

Our limited exercise further demonstrates that each alternative that presents itself to us in the design of a complete antenna system has different consequences that are worth evaluating in detail. Sometimes, a difference makes little difference to operations, and we may select among the options based on such factors as cost or convenience. In other cases, the differences can be electrically significant, even to the level of justifying an additional investment to obtain better results.