

Notes on Standard Design HF LPDAs, Pt 1: “Short” Boom Designs

“Short” is a relative term here. These 3 to 30-MHz wide-band antennas have a 167-ft longest element on a 100-ft boom. Definitely a job for computer modeling!

By L. B. Cebik, W4RNL

Hams have heard of 3-30 MHz dream antennas of log-periodic dipole array (LPDA) design since their advent. While wide-band LPDAs are common in governmental and commercial circles, little performance or specification data on the antennas has filtered into amateur publications. LPDAs for 14-20 MHz are much more common. Because modeling software (*NEC-4*) exists to assess the potential for 3.5-octave LPDAs, and because curiosity must ultimately be served, I began a preliminary modeling study, the first two parts of which appear in this series.

The first part of this preliminary study looks at standard LPDA designs of the order produced by *LPCAD* for three 3-30 MHz antennas:

- 60-ft boom with 20 elements
- 100-ft boom with 20 elements
- 100-ft boom with 26 elements

The 60-foot boom length is not recommended because of difficulties in obtaining an SWR of less than 2:1 across the passband relative to some common impedance and because of very significant pattern anomalies at numerous frequencies.

More feasible is a 100-ft boom using either 20 or 26 elements, if a free-space forward gain of less than 6.0 dBi is acceptable across the passband. Except at the lowest frequencies, the front-to-back ratio is acceptable (more than 18 dB from

9 MHz upward), although rear lobes are broader than would be expected for an LPDA of narrower frequency range. By careful selection of the interelement transmission-line value and the use of an antenna line terminating stub, an SWR of under 2:1 can be obtained for the entire passband with only small (and likely correctable) exceptions.

For some designs—especially the 100-ft boom, 20-element version—element diameter tapering according to the value of Tau shows significant improvements across the passband. However, this technique results in unrealistically large diameters for the tubular elements. A possible wire simulation of the large elements is proposed, along with a simple mechanism for shortening the physical

length of the element while preserving its resonant frequency.

Preliminary Design and Modeling Considerations

Flat-plane LPDAs are normally designed in accord with well-published design equations. There are several LPDA design programs employing these equations, of which *LPCAD* by Roger Cox may be the best known and most widely distributed. The 3-30 MHz LPDAs described here were initially designed using *LPCAD*. Since the theory and equations for standard LPDA designs appear in so many publications, they will be only briefly noted here.

Tau is the ratio between element lengths. It is, as Fig 1 shows, also the ratio of element distances from the center of a circle such that the element lengths define an arc having a constant angle. Since the angle, which is twice Alpha, is often difficult to work with, we may also define a spacing constant, Sigma. Sigma can be defined, as shown in the diagram, in terms of Tau and Alpha, but often it is more convenient to calculate it by taking the spacing of any two elements and dividing that distance by twice the length of the longer element.

For dipole arrays, there is an optimal value for Sigma:

$$\text{Sigma}_{\text{opt}} = (0.243 \text{ Tau}) - 0.051 \text{ (Eq 1)}$$

Suppose we opt for a Tau value of 0.94. The optimal value of sigma will be 0.1774. Plugging this value back into the equation by which we determine Alpha yields an angle of about 4.833°; this results, in turn, in a very long boom. For a 3-30 MHz LPDA with a longest element of 167.28 ft, the boom length becomes about 989 ft.

For most applications, much shorter lengths are physically required for LPDAs. The immediate consequence is a reduction in gain, along with irregularities in gain across the design passband of the array. When the length becomes too short, pattern shaping also tends to become irregular and often unusable at many frequencies within the passband of the LPDA design. Finally, obtaining a relatively constant source impedance across the passband becomes nigh well impossible.

One of the initial goals of this preliminary study was to determine the approximate shortest length that would be feasible for a 3-30 MHz LPDA. Since antenna gain has not been specified in advance, the criteria for an acceptable length included the ability

of the antenna to achieve a 2:1 SWR across the passband relative to some specific impedance value. In addition, free-space azimuth patterns must achieve reasonable shapes for all test frequencies, with no spurious forward or rearward lobes of consequence.

An additional goal of this preliminary study was to look at the effect of element diameter upon antenna performance. Standard (but simplified) tubing diameter progressions would be compared to element diameters increased for each element by the value of Tau used in the element-length schedule. The latter schedule of element diameters would result in a constant length-to-diameter ratio for the entire array.

The designs resulting from *LPCAD* inputs were modeled on *NEC-4* (*EZNEC*) using aluminum elements throughout. The environment selected

was free space, so that all values reported would be comparable and not subject to variations due to height above ground. The resulting models were sizable: 836 segments for 20-element versions and 1184 segments for 26-element versions of the LPDA. Even on a 400-MHz computer, the run time for the models—especially for frequency sweeps from 3 to 30 MHz in 1-MHz increments—limited the number of variations possible. Consequently, there are design modification possibilities that have not been explored in these preliminary notes. Moreover, instead of a survey of boom lengths in small increments, only two selected boom lengths could be initially checked: 60 and 100 ft. Whether an intermediate length realizes the improvements found in the 100-ft boom length was not determined.

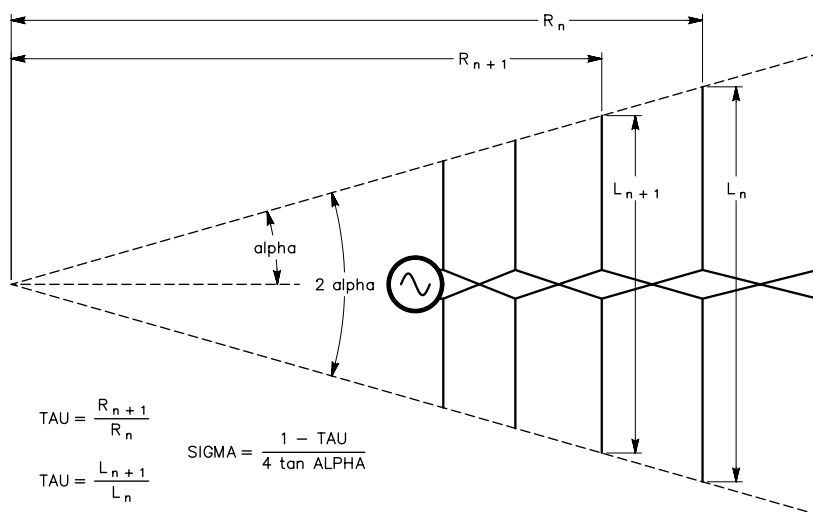

Fig 1—Some of the basic relations used in standard LPDA design [adapted from Richard C. Johnson, Ed., *Antenna Engineering Handbook*, 3rd ed. (New York: McGraw-Hill, 1993), p 14-36.]

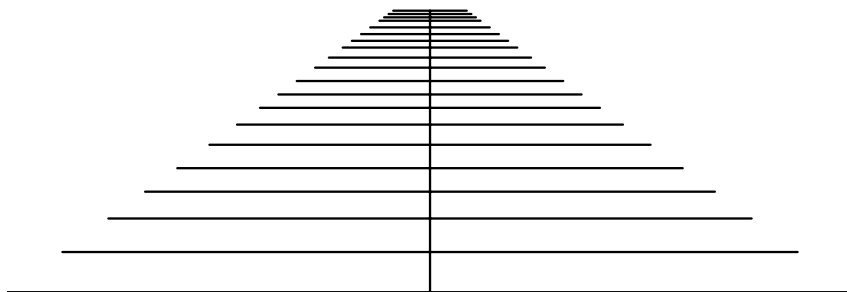

Fig 2—Outline of the 60-ft, 20-element 3-30 MHz LPDA.

The models themselves are further limited by the use of the TL facility in NEC—the mathematical modeling of transmission lines used to interconnect elements. Physical models of LPDAs with transmission lines are not feasible due to certain limitations in NEC, most notably the angular junction of wires of dissimilar diameter. However, mathematical transmission lines do not account for losses in these lines, and therefore, all performance figures may be very slightly off the mark.

Within these limitations, certain trends are notable and reported in the following.

A 60-ft, 20-Element LPDA

The first model developed used a 60-ft boom length with 20 elements ranging from 2.0 inches in diameter at the rear to 0.5 inch in diameter for the shortest element. Based on initial modeling tests for a “best” SWR curve, the interelement transmission line was set at 150 Ω. The *EZNEC* model description is appended at the end of the report to show the facets of design, including the tubing schedule. In general, each diameter divisible by 1/4 inch is used twice, while those divisible only by 1/8 inch are used only once in the element progression.

Fig 2 displays the generalized outline of the 60 ft, 20-element LPDA used in this study. The longest element is 2007 inches (or about 167 ft), while the shortest is 155 inches (or about 13 ft). See Table 1 for a listing of element half-lengths and cumulative spacing for the final model design. For this design, overall length

Table 1—Element half-lengths and cumulative spacing of the 60-ft, 20-element 3-30 MHz LPDA model

Element	Half Length (inches)	Cumulative Spacing (inches)
1	1003.68	0.00
2	876.93	98.50
3	766.19	184.56
4	669.44	259.75
5	584.90	325.45
6	511.04	382.85
7	446.50	433.00
8	390.12	476.82
9	340.85	515.11
10	297.81	546.56
11	260.20	577.79
12	227.34	603.32
13	198.65	625.63
14	173.55	645.13
15	151.63	662.16
16	132.49	677.04
17	115.76	690.04
18	101.14	701.40
19	88.37	711.33
20	77.21	720.00

and the number of elements were specified, with the values of Tau (0.87) and Sigma (0.02) becoming the results of the calculations. It is interesting that *LPCAD* initially predicted a free-space forward gain of about 6.5 dBi, with front-to-back ratios ranging from 13 to 19 dB. Only the front-to-back ratios met the prediction. Although a 150-Ω transmission line was finally used, *LPCAD* recommended a 200-Ω line and predicted that the antenna input resistance would be about 85 Ω.

Apparently, the 60-ft boom length is categorically unable to yield a SWR under 2:1 for any particular reference impedance value. Using 1-MHz increments from 3 to 30 MHz, impedance values varied widely. The range of the resistive component was from a 24 Ω low to a 168 Ω high. Reactance varied between -68 Ω and +71 Ω. The SWR curve for the 3-30 MHz passband, shown in Fig 3, reveals only a couple of minor excursions below 2:1 relative to a 75-Ω reference value. Other reference values will yield more values below 2:1, but the peak values of SWR climb proportionately. The result is a

design that is unlikely to be matchable to standard feed lines by any straightforward means.

In addition to an unacceptable set of SWR values across the passband, the 60-ft, 20-element design also shows numerous pattern anomalies. Often, an LPDA design will show a small frequency region of unacceptable pattern shape. Such problems are sometimes amenable to input-stub correction. However, the present design shows anomalies at many frequencies.

Table 2 samples performance values at 3-MHz intervals across the passband and reveals the general performance trends for the antenna. The table reveals some strong difficulties at the lower and upper ends of the passband. The gain and front-to-back ratio at 3 MHz is exceptionally low and only slowly improves as the frequency progresses toward 9 MHz. At the upper end of the passband, the source impedance reaches very low values. The gain shows large excursions throughout the 3 to 30 MHz range.

Some selected free-space azimuth patterns for 3, 9, 15 and 30 MHz can

Table 2 —Performance of the 60-ft, 20-element model LPDA at 3-MHz increments from 3-30 MHz

Frequency (MHz)	Free-Space Gain (dBi)	Front-to-Back Ratio (dB)	Source Impedance ($R \pm jX \Omega$)	SWR (75-Ω)
3	3.66	3.6	120 -j68	2.30
6	5.93	10.2	168 +j40	2.39
9	4.88	16.1	108 +j63	2.16
12	5.50	16.4	162 +j11	2.18
15	6.00	18.7	35 +j12	2.24
18	5.36	19.0	86 +j60	2.09
21	6.08	18.7	124 +j50	2.04
24	6.01	18.7	81 +j50	1.89
27	5.18	17.5	25 +j27	3.47
30	5.64	18.7	27 -j24	3.05

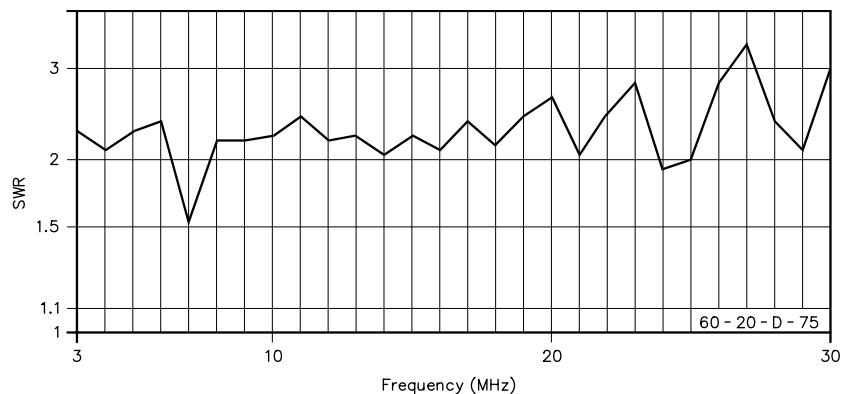

Fig 3—3-30 MHz SWR sweep of the 60-ft, 20-element LPDA model referenced to 75 Ω.

reveal other weaknesses in the design. The 3-MHz pattern in Fig 4 reveals clearly the very weak directional pattern for the design at its lowest frequency. Although gain and front-

to-back ratio improve as frequency is increased, the size of the rear lobes at 9 MHz is still very much larger than is desirable for most operation.

The 15-MHz pattern in Fig 4 reveals

a double forward lobe, along with added side lobes in both the forward and rearward quadrants. Although this pattern might be corrected to some degree by compensatory loading, the fact that a similar set of problems attach to the 30-MHz pattern largely precludes this course of action. There would still be sets of frequencies with unacceptable azimuth patterns.

The general conclusion to be reached from this exploration is that the standard LPDA design—as produced by *LPCAD*—yields unacceptable results. Moreover, the problematical performance numbers are unlikely to be overcome by compensatory actions on the design. In the end, a 60-ft boom is simply too short for a standard LPDA design to achieve any set of desired goals.

100-ft, 20-Element LPDA

Since the model sizes precluded incremental investigation with the goal of finding the shortest acceptable boom, a longer boom was arbitrarily selected for modeling. A 100-ft length was chosen because it seemed sufficiently longer than the 60-ft boom (167%) to offer significantly modified antenna behavior. The parameters were presented to *LPCAD*, which produced a design with the same element lengths as used in the 60-ft design, but with a new spacing schedule. Fig 5 shows the general outline of the longer design, while Table 3 provides element half-lengths and cumulative spacing for the model. Initially, the tubing diameter schedule used in the 60-ft-boom model was

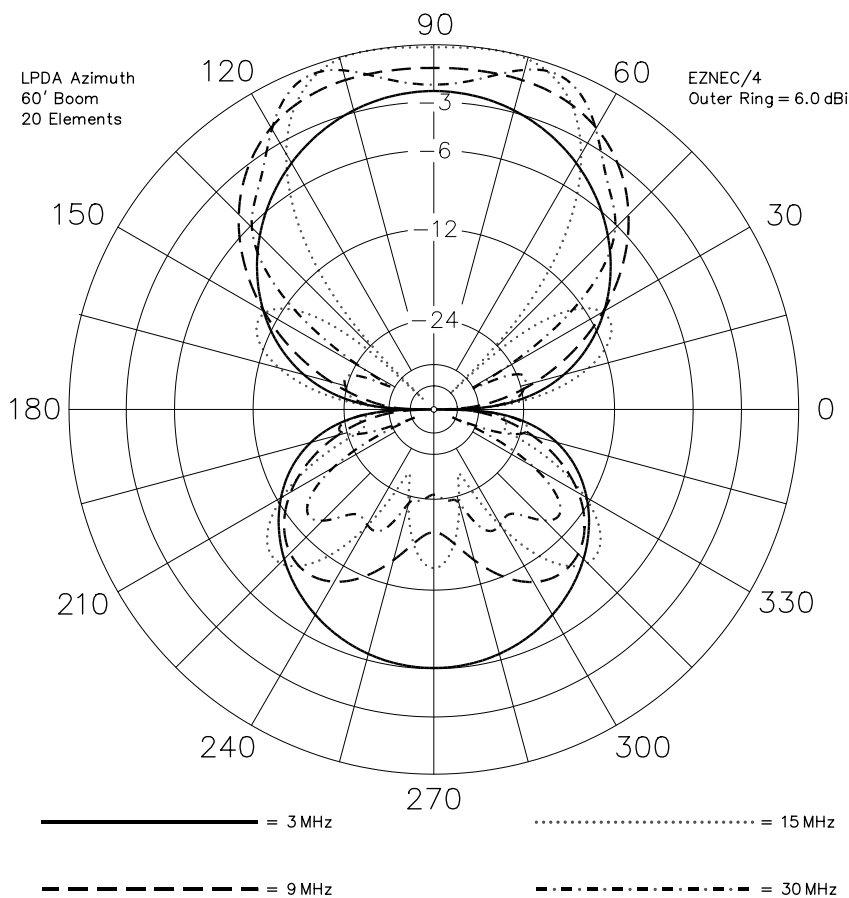

Fig 4—Free-space azimuth pattern of the 60-ft, 20-element LPDA model at 3, 9, 15 and 30 MHz.

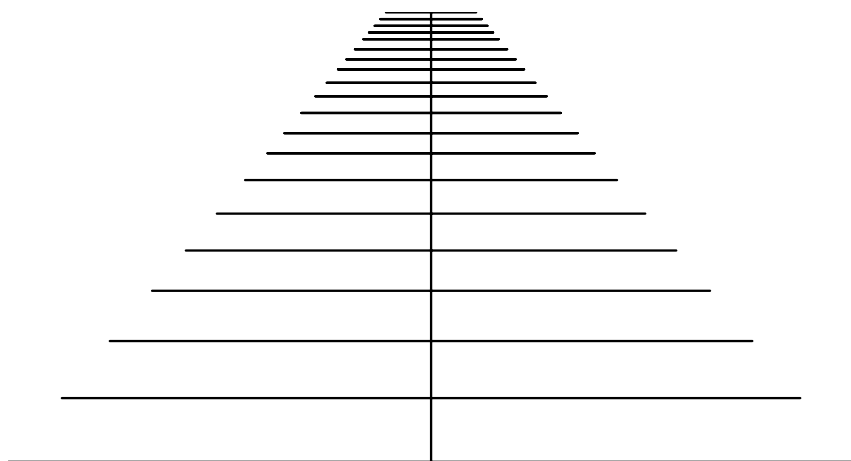

Fig 5—Outline of the 100-ft, 20-element 3-30 MHz LPDA.

Table 3—Element half-lengths and cumulative spacing of the 100-ft, 20-element 3-30 MHz LPDA model

Element	Half Length (inches)	Cumulative Spacing (inches)
1	1003.68	0.00
2	876.93	164.17
3	766.19	307.60
4	669.44	432.92
5	584.90	542.42
6	511.04	638.09
7	446.50	721.68
8	390.12	794.71
9	340.85	858.52
10	297.81	914.28
11	260.20	962.98
12	227.34	1005.54
13	198.65	1042.72
14	173.55	1075.21
15	151.63	1103.60
16	132.49	1128.40
17	115.76	1150.07
18	101.14	1169.00
19	88.37	1185.55
20	77.21	1200.00

transferred to the new 100-ft version.

The interelement transmission line impedance was set at 200 Ω, in accord with *LPCAD* recommendations. To this and all subsequent models in Part 1 of these notes, I added a 90-inch shorted stub at the end of the line at the longest element to effect a transmission-line termination. In all cases, this stub has the same characteristic impedance as the interelement line. Again, because models are so large, varying the length of this stub might produce small improvements in the projected performance of some of the models. However, it is unlikely that major changes will be created.

As revealed in Fig 6, the 100-ft boom, 20-element LPDA is capable of a quite good SWR curve relative to a reference value of 95 Ω (in contrast to the *LPCAD* predicted input resistance of 103 Ω). Only once (in the 1-MHz increment scan) does the SWR value just barely exceed 2.0. Consequently, the antenna design passes one of the major criteria of acceptability.

LPCAD predicted that the antenna free-space gain would be about 6.5 dBi, with front-to-back ratios ranging from 13 to 19 dB. In some performance categories, the antenna shows a few serious shortcomings, especially with respect

to gain. Table 4 presents selected frequency performance figures, which reveal some of the design's weakness. The notation "BFL" records a judgment that the antenna at the given frequency exhibits a *broad forward lobe*. However, even where technically double, the difference between the forward direction and the peak is under 0.5 dB and therefore is more accurately called a broad lobe than a double lobe.

The gain at the lower end of the passband remains low, but slightly better than that of the 60-ft model. Numerous test frequencies show broad frontal lobes, with equally wide rear lobes, although the front-to-back ratio is very consistent from 12 MHz upward. Moreover, the gain figures, while lower on some bands than those of the 60-ft model, are far more consistent from one test frequency to the next. All in all, the 100-ft, 20-element version of the LPDA shows distinct improvements over the 60-ft model.

Although the model uses a set of element diameters that increase as frequency decreases, the rate of increase does not match the inverse of Tau (0.87). Table 5 gives a comparison of the initially modeled and the "Tau-tapered" element diameters, counting from element 20 at the highest fre-

quency downward toward element 1 at the lowest frequency.

The element diameters remain roughly the same for the shortest seven elements. Then the rigorous "Tau-tapering" schedule increases the element diameter much more rapidly, reaching a final value of 6.5 inches for the longest element. Although this element diameter may be impractical in a tubular design, there may be a way of simulating such elements. One possibility will be suggested in the final section of these notes.

To test whether the "Tau-taper" element set would make a difference in the performance predicted by *NEC-4*, the 100-ft model was reset using the new element diameters. For the initial test, I retained the 200-Ω interelement feed line, the 90-inch terminating stub and the SWR reference impedance of 95 Ω. The resulting SWR curve in Fig 7 remains quite good, with only one slight excursion above 2:1.

Table 6 reveals the performance improvements that occur at the lower end of the antenna passband. Relative to the original 100-ft model, the "Tau-tapered" model shows improved front-to-back ratio at every frequency. Gain at 3 MHz is improved so that it never drops below 5 dBi throughout the entire frequency range for the frequencies tested. Only at 18, 27 and 30 MHz is the gain of the new model slightly lower than for its companion. However, the frequencies at which we encounter broad forward lobes (BFL) remain constant between the two models. The

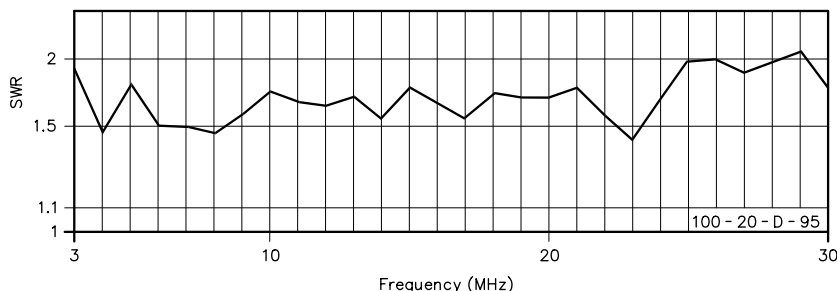

Fig 6—3-30 MHz SWR sweep of the 100-ft, 20-element LPDA model referenced to 95 Ω.

Table 4—Performance of the 100-ft, 20-element model LPDA at 3-MHz increments from 3-30 MHz "BFL" means broad forward lobe (see text).

Frequency (MHz)	Free-Space Gain (dBi)	Front-to-Back Ratio (dB)	Source Impedance ($R \pm jX \Omega$)	SWR (95-Ω)	
3	4.70	6.9	148 -j57	1.91	
6	6.02	15.2	67 -j18	1.52	
9	5.60	17.7	71 -j29	1.58	
12	4.95	19.1	61 -j17	1.64	BFL
15	5.56	21.8	167 -j11	1.77	
18	5.32	18.7	80 -j46	1.73	BFL
21	5.27	22.0	71 -j40	1.75	BFL
24	5.07	22.7	81 -j43	1.68	BFL
27	5.21	20.9	166 +j37	1.87	BFL
30	5.23	20.9	55 +j16	1.78	

Table 5—Comparison of the element diameters for the initial and "Tau-tapered" versions of the 100-ft, 20-element LPDA model. Diameters are in inches.

Element	Initial	Tau-Taper
20	0.50	0.50
19	0.50	0.57
18	0.625	0.66
17	0.75	0.75
16	0.75	0.86
15	0.875	0.98
14	1.00	1.12
13	1.00	1.29
12	1.125	1.47
11	1.25	1.69
10	1.25	1.93
9	1.375	2.21
8	1.50	2.53
7	1.50	2.89
6	1.625	3.31
5	1.75	3.79
4	1.75	4.34
3	1.875	4.96
2	2.00	5.68
1	2.00	6.50

improvements at the lowest frequencies alone strongly suggest that the longest elements may benefit from increased diameter.

100-ft, 26-Element LPDA

If 20 elements provide a baseline of performance for the 100-ft long standard LPDA, would more elements yield

further improvements? Additional elements would reduce the separation of resonant frequencies from one element to the next.

A 26-element model, outlined in Fig 8, was created using an extension of the original element-diameter scheme so that the longest elements are 2.5 inches in diameter. Despite the

increased diameter of the longest element (still 167 ft long), there is considerable disparity of length-to-diameter ratio between it and the shortest element. Table 7 lists the element half-lengths and cumulative spacing for the model. *LPCAD* predicted a gain of 7 dBi, with front-to-back ratios ranging from 17 to 23 dB. The Tau for the model is 0.90, with a Sigma of 0.03. With a recommended 200-Ω interelement feed line, *LPCAD* predicted the feed-point impedance to be 93 Ω.

Modeling of the antenna on *NEC-4* suggested the use of a 150-Ω interelement feed line, with retention of the 90-inch terminating stub. The resulting SWR curve, referenced to 75 Ω as shown in Fig 9, is quite good. Excursions above 2:1 SWR values occur only at the high end of the passband.

Relative to the comparable 20-element model, the 26-element model shows detectable improvements in performance at virtually every test frequency. Gain is up by perhaps 0.25 dB on average, and the front-to-back ratio exceeds 20 dB more consistently. In almost all cases, the 26-element model also shows improvements over the “Tau-tapered” version of the 20-element model.

Nonetheless, as Table 8 demonstrates, the gain of the standard-design LPDA rarely reaches 6 dBi, a figure common to monoband two-element

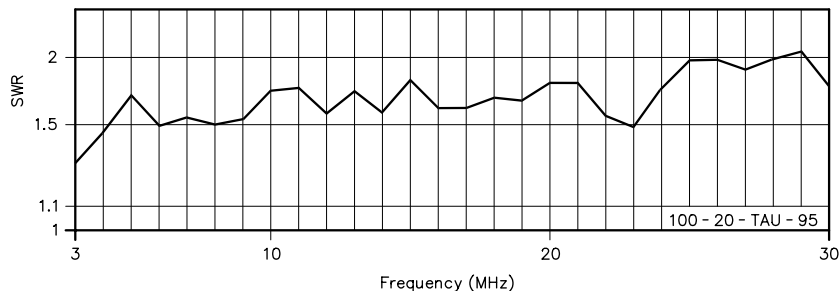

Fig 7—3-30 MHz SWR sweep of the 100-ft, 20-element LPDA model (with “Tau-tapered” element diameters) referenced to 95 Ω.

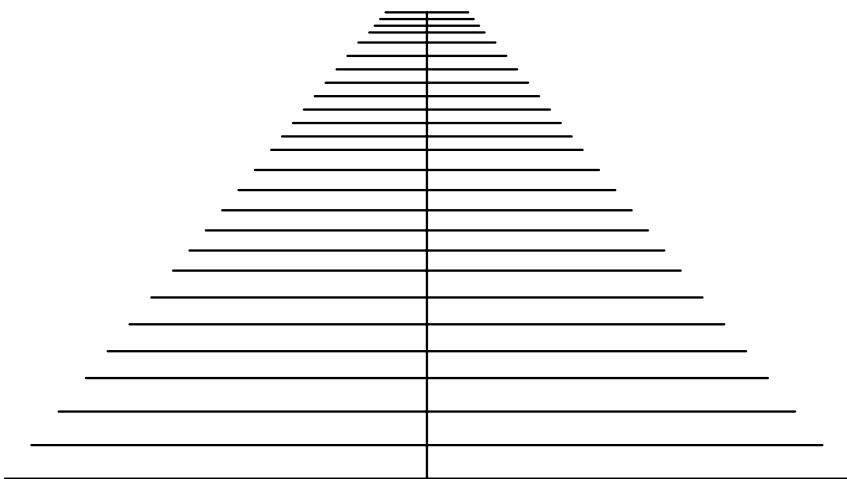

Fig 8—Outline of the 100-ft, 26-element 3-30 MHz LPDA.

Table 6—Performance of the 100-ft, 20-element model LPDA with “Tau-tapered” element diameters at 3-MHz increments from 3-30 MHz “BFL” means broad forward lobe (see text)

Frequency (MHz)	Free-Space Gain (dBi)	Front-to-Back Ratio (dB)	Source Impedance ($R \pm jX \Omega$)	SWR (95-Ω)
3	5.05	8.3	85 -j22	1.31
6	6.14	15.9	66 +j5	1.50
9	5.61	18.4	64 -j15	1.54
12	5.06	20.8	61 -j9	1.57
15	5.61	22.8	170 -j15	1.81
18	5.20	19.3	80 -j44	1.69
21	5.41	23.1	71 -j42	1.79
24	5.15	22.8	86 -j50	1.74
27	5.01	21.3	159 +j47	1.89
30	5.18	22.1	55 +j12	1.76

Table 7—Element half-lengths and cumulative spacing of the 100-ft, 26-element 3-30 MHz LPDA model

Element	Half Length (inches)	Cumulative Spacing (inches)
1	1003.68	0.00
2	905.81	126.76
3	817.49	241.17
4	737.77	344.41
5	655.83	437.59
6	600.91	521.69
7	542.31	597.58
8	489.43	666.07
9	441.71	727.89
10	398.64	783.64
11	359.76	834.02
12	324.68	879.46
13	293.02	920.47
14	264.45	957.47
15	238.66	990.87
16	215.39	1021.01
17	194.39	1048.22
18	175.43	1072.77
19	158.33	1094.93
20	142.89	1114.93
21	128.96	1132.97
22	116.38	1149.26
23	105.03	1163.96
24	94.79	1177.22
25	85.55	1189.20
26	77.21	1200.00

Yagis. The standard design predictions for gain, as reflected in the *LPCAD* implementation, overestimate gain by a full decibel. It likely would require a considerably longer boom to achieve the predicted 7 dBi figure in *NEC-4* models.

Except for diminished performance at the lowest test frequencies, this LPDA shows good consistency for most of the passband. The number of test frequencies at which we encounter broad forward lobes (BFL) is reduced relative to the 20-element model. If the modest forward gain figures are acceptable, this model or a variant would likely meet

both the SWR and pattern-shape criteria set forth earlier in this study.

The 26-element model uses 2.5-inch diameter elements for the lowest frequencies—a significant increase over the largest diameter used in the 20-element model. Whether a “Tau-taper” element set might effect any improvements became the next question. With a Tau of 0.903, the requisite element set showed the sizes listed in Table 9, once more set against the element-diameter schedule for the initial 26-element model.

The resulting model uses the same

150 Ω inter-element transmission line as used in the initial 26-element model. The SWR curve is well behaved, with excursions into values above 2:1 occurring only at the upper frequencies. If we set the reference impedance to 65 Ω, the maximum SWR is about 2.17:1 at 28 and 29 MHz, as shown in Fig 10. Use of this reference value results in a rougher curve for other frequencies than it might otherwise be.

If we select 75 Ω as the reference impedance for the SWR curve, as was done for Fig 11, values for frequencies under 20 MHz show a lower SWR, but the peak SWR value at 28 MHz rises to 2.49:1. Of course, the actual source impedances have not changed, but the choice of reference impedance may have a bearing on the selection of means to match the antenna to a specific main feed line for the system.

Except for the lowest frequencies, the gain performance of the “Tau-tapered” version of this model is slightly under that of the initial model. The result owes partially to the greater diameter of the rear elements (2.5 inches) in the initial 26-element model. Table 10 is instructive. SWR values are referenced to 65 Ω. Except perhaps for 3 MHz, there is nothing overall to choose between the two 26-element models. The number of cases of “broad forward

Table 8—Performance of the 100-ft, 26-element model LPDA at 3-MHz increments from 3-30 MHz “BFL” means broad forward lobe (see text)

Frequency (MHz)	Free-Space Gain (dBi)	Front-to-Back Ratio (dB)	Source Impedance ($R \pm jX \Omega$)	SWR (75-Ω)	
3	5.08	8.5	71 -j7	1.12	
6	6.24	16.4	64 -j31	1.61	
9	5.97	18.4	92 -j34	1.58	
12	5.90	20.5	95 +j26	1.62	
15	5.65	19.8	117 +j15	1.61	BFL
18	5.95	21.2	51 +j21	1.68	
21	5.44	21.8	108 -j16	1.50	
24	5.80	22.4	67 -j37	1.69	BFL
27	5.66	21.8	49 -j30	1.91	BFL
30	5.69	20.6	106 -j49	1.89	

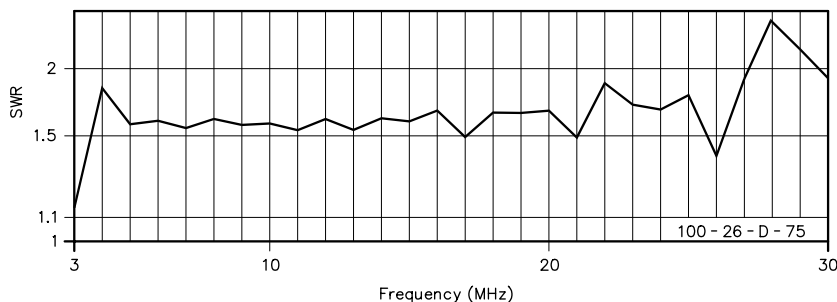

Fig 9—3-30 MHz SWR sweep of the 100-ft, 26-element LPDA model referenced to 75 Ω.

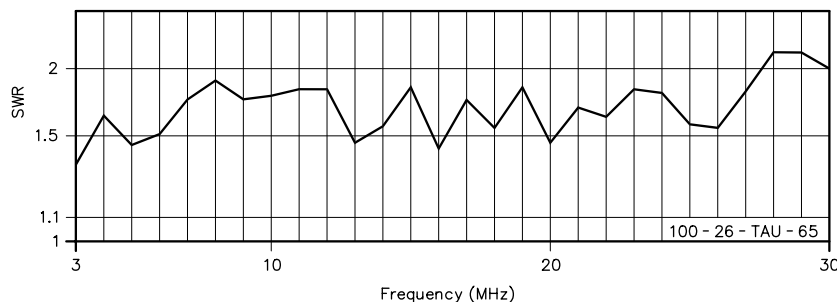

Fig 10—3-30 MHz SWR sweep of the 100-ft, 26-element LPDA model (with “Tau-tapered” element diameters) referenced to 65 Ω.

Table 9—Comparison of the element diameters for the initial and “Tau-tapered” versions of the 100-ft, 26-element LPDA model Diameters are in inches.

Element	Initial	Tau-Taper
26	0.50	0.50
25	0.50	0.56
24	0.625	0.62
23	0.75	0.69
22	0.75	0.76
21	0.875	0.85
20	1.00	0.94
19	1.00	1.04
18	1.125	1.15
17	1.25	1.27
16	1.25	1.41
15	1.375	1.56
14	1.50	1.73
13	1.50	1.91
12	1.625	2.12
11	1.75	2.34
10	1.75	2.59
9	1.825	2.87
8	2.00	3.18
7	2.00	3.52
6	2.125	3.90
5	2.25	4.32
4	2.25	4.79
3	2.375	5.30
2	2.50	5.87
1	2.50	6.50

lobe” (BFL) continues to diminish with each improved model.

However, the entire progression of models at the 100-ft length has shown significant improvements over the 60-ft model. How much improvement we have made can be judged by the following series of free-space azimuth patterns taken at 3, 9, 15 and 30 MHz. These are the same frequencies used for patterns of the 60-ft model. Directly comparing the patterns in Fig 12 with those in Fig 4 provides a measure of the improvements made by increasing the boom length and number of elements.

The 3-MHz pattern in Fig 12 shows the same circularity of the forward and rear lobes as does the 3 MHz 60-ft model pattern. However, the improved gain and front-to-back ratio are readily apparent. The 9-MHz pattern for the “Tau-tapered” 100-ft, 26-element model shows far better control (relative to the 60-ft model) of the rear lobe, despite its broadness.

The 60-ft model showed a many-lobed pattern at 15 MHz. In Fig 12, the 26-element model shows only forward and rearward lobes at the same frequency. The forward lobe is technically a double lobe, but the center-point is down only a fraction of a decibel, far too little to be detected in operation. Nonetheless, this lobe, like the lobes at many frequencies, continues to be somewhat broader than those associated with monoband Yagi antennas. At 30 MHz, the 26-element “Tau-tapered” model shows a similar pattern, although technically having only a single peak value. The irregularities on the sides of the forward lobe and all around the rear lobe are incipient secondary lobes created by the cumulative effects of the elements behind the shortest elements. Although current magnitudes in the longer elements are low, together they add remnant multiwavelength, multilobe facets to the 30-MHz pattern.

Fuller Frequency Sweeps

There are dangers associated with performing only spot performance checks at 3-MHz intervals. Therefore, I ran some 0.5-MHz-increment frequency sweeps of the tubing and the “Tau-tapered” element versions of the 100-ft, 26-element design. The purpose was to determine whether there were any hidden oddities of performance in either design. Although superior to checks at 3-MHz intervals,

Table 10—Performance of the 100-ft, 26-element model LPDA with “Tau-tapered” element diameters at 3-MHz increments from 3-30 MHz “BFL” means broad forward lobe (see text)

Frequency (MHz)	Free-Space Gain (dBi)	Front-to-Back Ratio (dB)	Source Impedance ($R \pm jX \Omega$)	SWR (65 Ω)
3	5.38	9.9	71 +j17	1.30
6	6.29	16.6	55 -j24	1.54
9	5.80	18.5	85 -j38	1.75
12	5.85	21.0	100 +j36	1.83
15	5.56	19.5	117 +j20	1.87
18	5.80	21.1	48 +j17	1.56
21	5.44	21.8	110 -j10	1.70
24	5.76	22.6	72 -j41	1.81
27	5.57	22.4	51 -j32	1.83
30	5.47	21.2	101 -j45	1.99

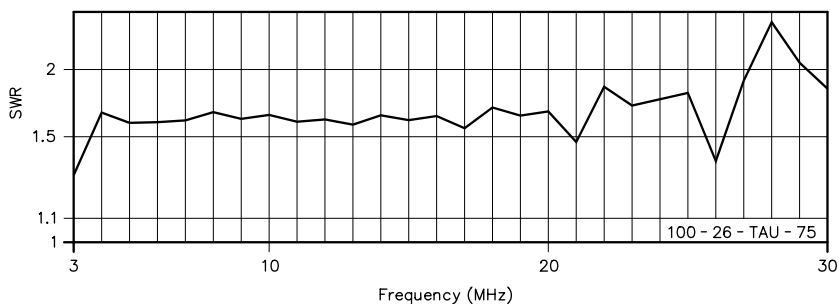

Fig 11—3-30 MHz SWR sweep of the 100-ft, 26-element LPDA model (with “Tau-tapered” element diameters) referenced to 75 Ω .

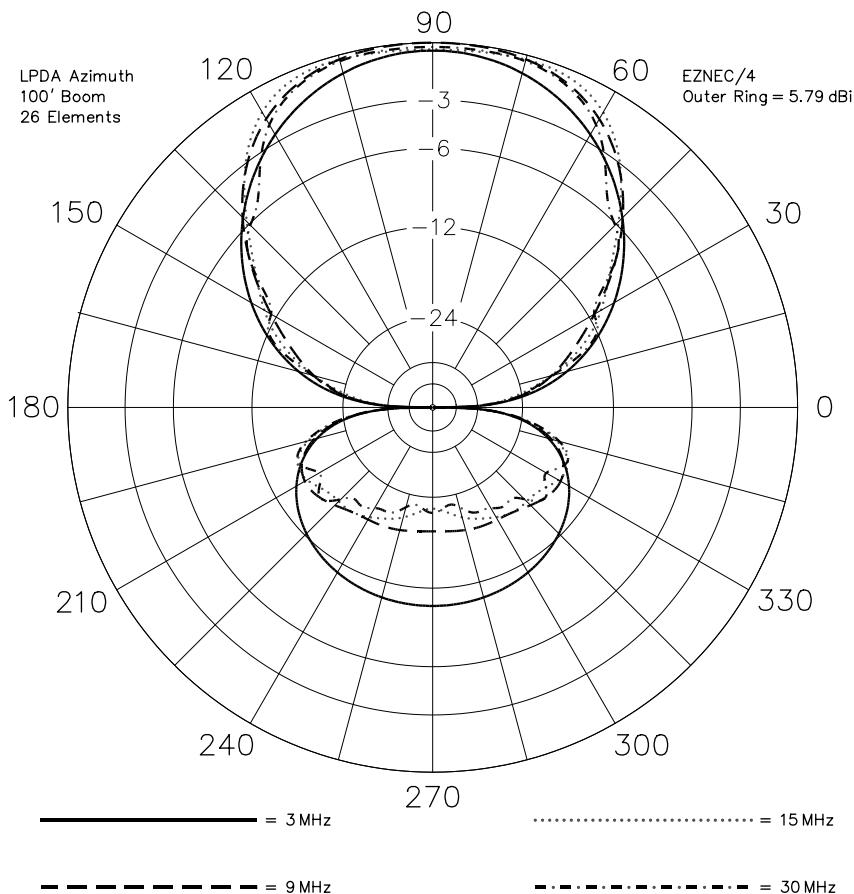

Fig 12—Free-space azimuth pattern of the 100-ft, 26-element LPDA model at 3, 9, 15 and 30 MHz.

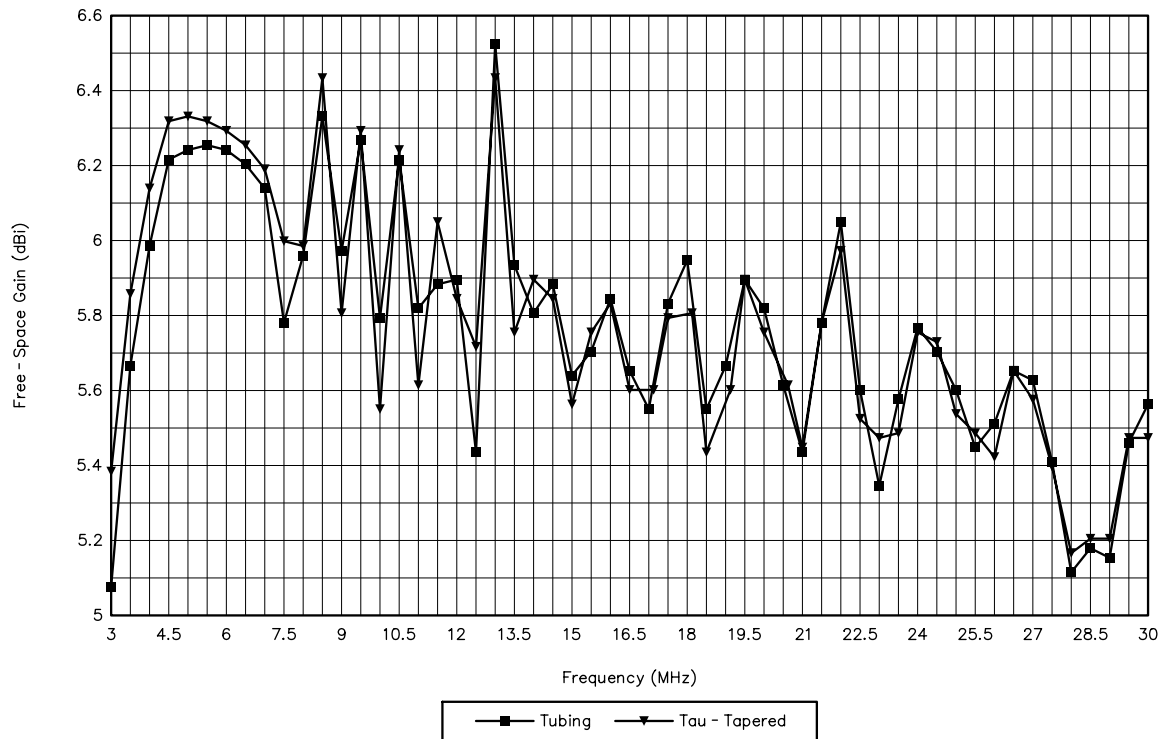

Fig 13—Frequency sweep at 0.5 MHz intervals of free-space gain (dBi) for both versions of the 100-ft, 26-element LPDA model.

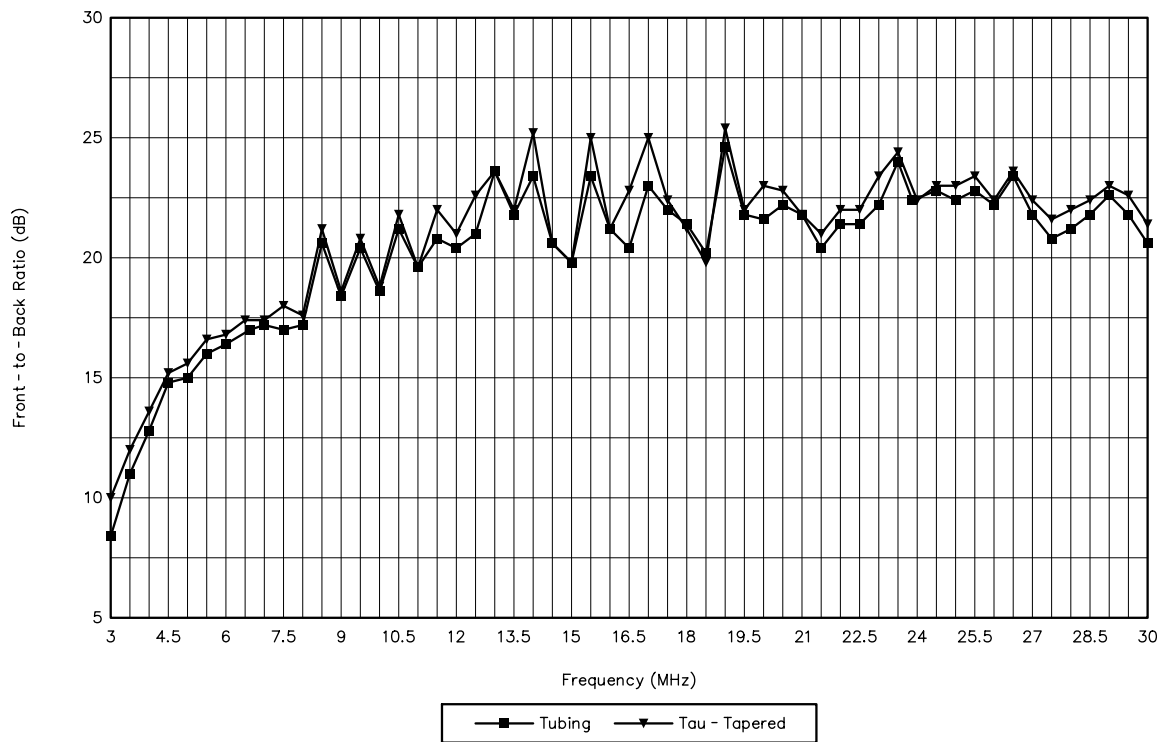

Fig 14—Frequency sweep at 0.5 MHz intervals of the front-to-back ratio (in dB) for both versions of the 100-ft, 26-element LPDA model.

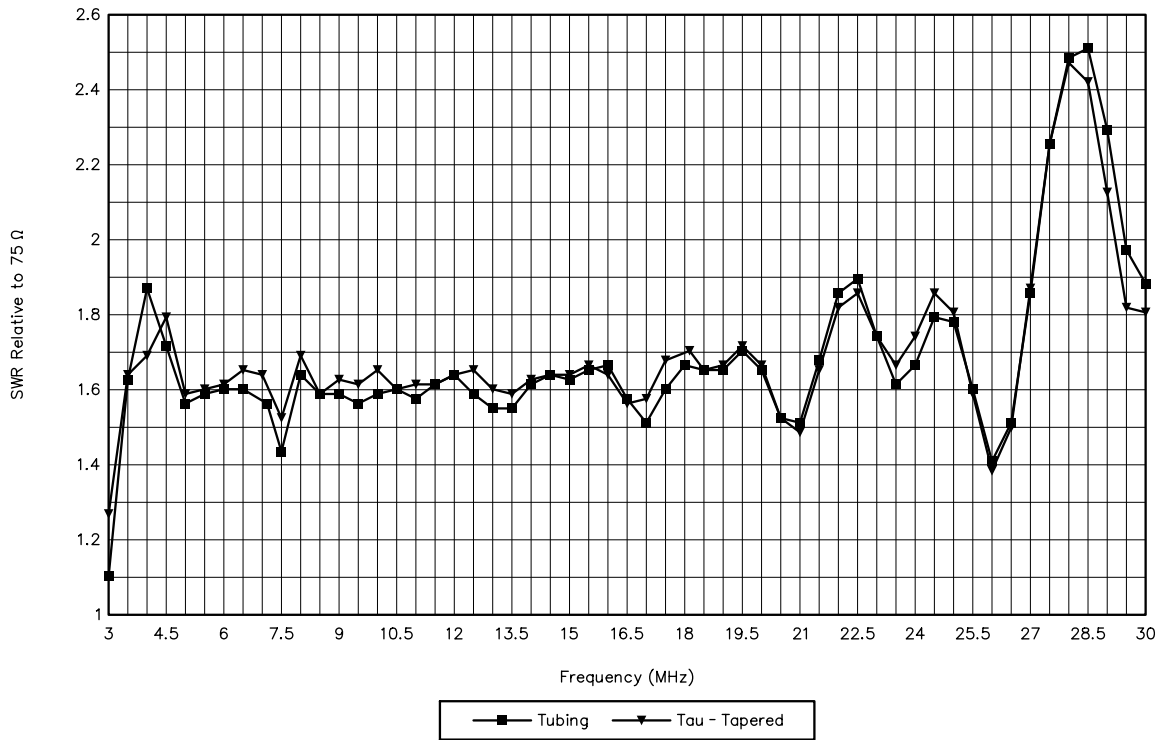

Fig 15—Frequency sweep at 0.5 MHz intervals of the 75-Ω SWR for both versions of the 100-ft, 26-element LPDA model.

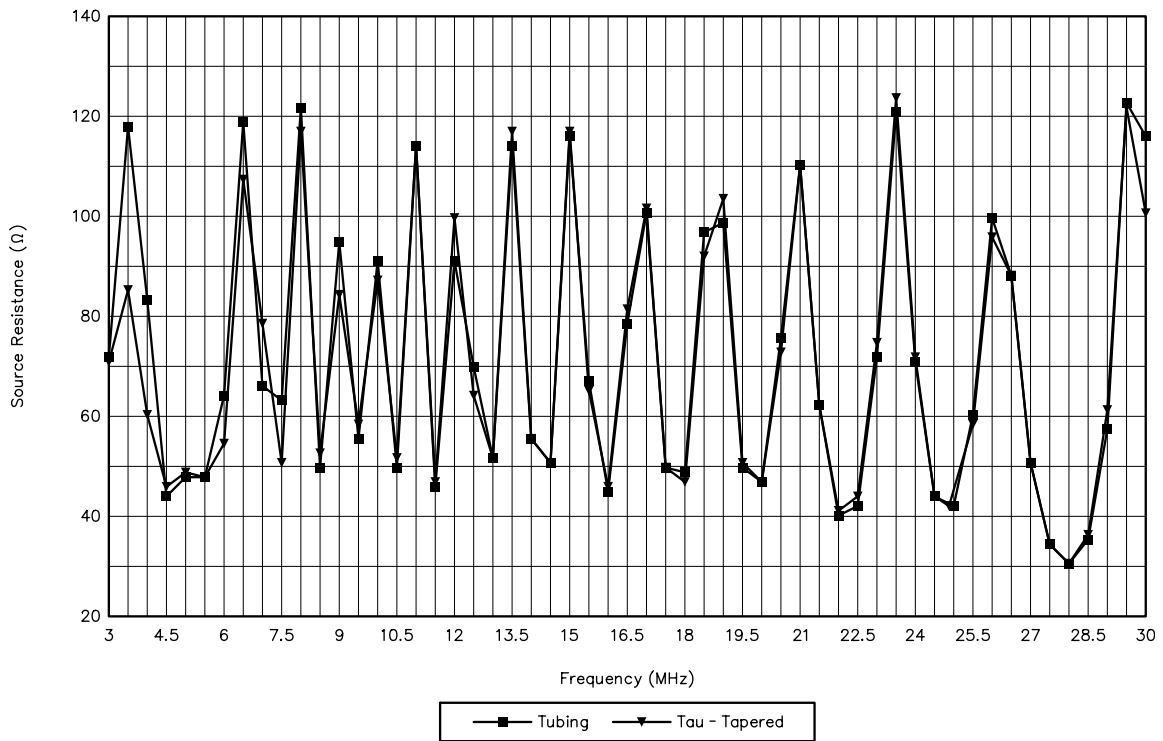

Fig 16—Frequency sweep at 0.5-MHz intervals of the feedpoint resistance (Ω) for both versions of the 100-ft, 26-element LPDA model.

even 0.5-MHz increments can miss some properties. Therefore, every LPDA design of interest should be swept at smaller intervals across every portion of the spectrum at which operation is contemplated.

The free-space gain graph in Fig 13 shows relatively good coincidence between the two design variants. However, in the lower third of the passband, the tubing version, which is limited to a maximum element diameter of 2.5 inches, shows greater excursions of free-space gain, including significantly lower values at 3 and 12.5 MHz.

The 180° front-to-back curves in Fig 14 are remarkably coincident across the entire passband. The 90-inch 150-Ω shorted stub used on both models smoothes the curve below 8.5 MHz, above which frequency the familiar sawtooth LPDA progression of values re-emerges.

The three final graphs should be read in this order: 75-Ω SWR (Fig 15), Source Resistance (Fig 16) and Source Reactance (Fig 17). The SWR curve in Fig 15 is quite smooth through at least 20 MHz, average a little over 1.6:1 relative to a 75-Ω standard. The illusion created by this curve is that the

source impedance has a fairly constant value across this range. As the following Source Resistance graph (Fig 16) shows, the actual resistive impedance varies over a range greater than 4:1. What holds the SWR values to a narrow range is the reactance associated with each resistance value, which appears in Fig 17. Resistance values near the impedance standard of 75 Ω are accompanied by high inductive or capacitive reactance values. Resistive values more distant from the standard have associated reactance values that are much lower. The exception is in the 27.5 to 29 MHz range, where low resistance values are accompanied by high reactance values.

Indeed, the fuller frequency sweeps did uncover some interesting properties of the 100-ft, 26-element LPDAs that the wider-interval checks left obscure. Initially, the curves were developed to compare the tubing and the “Tau-tapered” element designs, but the interesting properties that emerged applied equally to both models.

Tentative Conclusions

Of the models evaluated in this part of the preliminary study, the 100-ft, 26-element versions provide the best

overall performance. Additional elements within the 100-ft length are unlikely to add significantly to performance. Only additional boom length—to provide a more satisfactory value of Sigma—would show increases in gain. However, the gain advantage may be offset by a reduction in lower-frequency performance if the element density is not maintained. With the element density set to at least 20 elements per 100 ft of boom and up to 26 elements per 100 ft, obtaining a satisfactory SWR curve and well-controlled pattern shapes for the array should pose no major problem.

Some modification of low-frequency performance can be obtained by adjustments to the terminating stub. In all cases, the final length should be obtained by experiment on the physical antenna in order to make all due allowance for interelement transmission-line losses, which the *NEC-4* models cannot take into account. As well, the shortest elements active in the formation of the 27 to 30 MHz patterns should be experimentally adjusted to obtain the best patterns and the most satisfactory impedance values. However, such empirical adjustments may also throw off the feedpoint impedance,

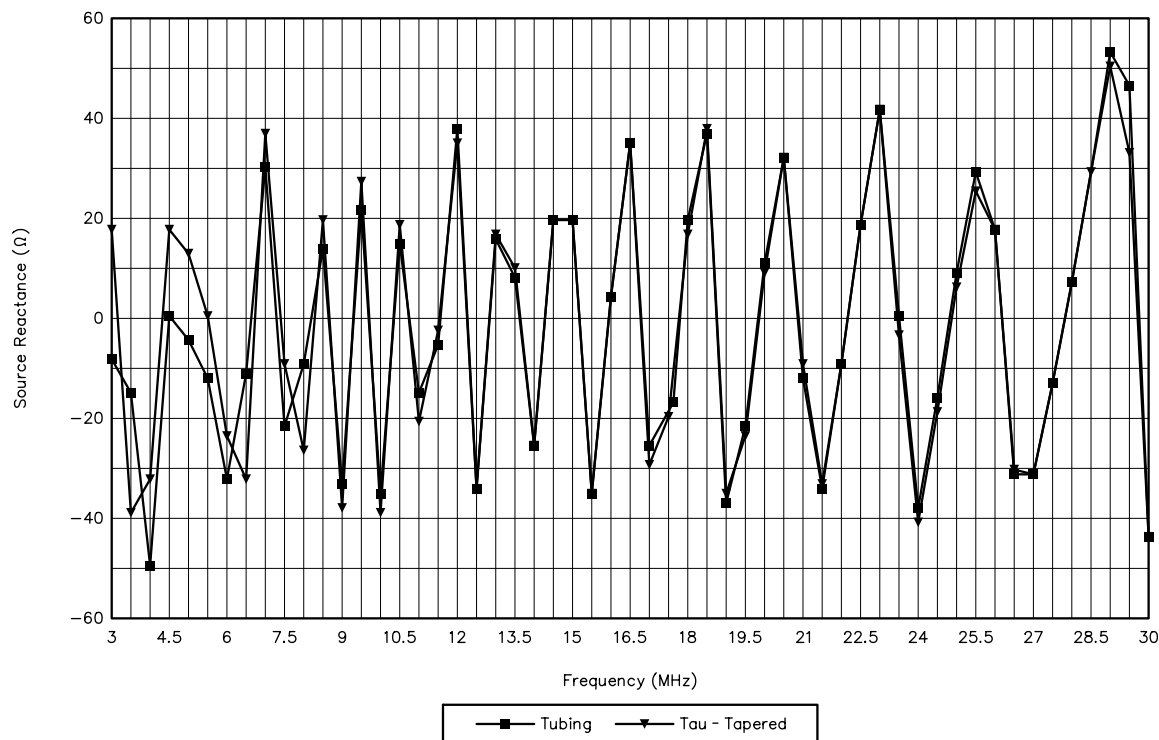

Fig 17—Frequency sweep at 0.5-MHz intervals of the feedpoint reactance (Ω) for both versions of the 100-ft, 26-element LPDA model.

even at frequencies distant from the ones for which element lengths and spacings are changed.

All of the models examined in these preliminary notes are of standard LPDA design. No attempt to use periodic element length techniques or other suggested enhancements has been attempted. Moreover, there are apparently some proprietary alternative algorithms said to provide improved performance across the 3-30 MHz spectrum. These algorithms are not accessible to me at present and therefore the designs that might result from them cannot be evaluated. Nonetheless, the general trends of standard LPDA designs have proven instructive in themselves.

Tau-Tapered Element Design

True “Tau-tapered” elements result in impractical element diameters. However, an alternative construction method might use wire instead of tubing.

For a given element with an assigned tubular diameter, there will be a self-resonant frequency. One may construct the same element in skeleton form from wire. The length can be made equal to the original element and the spacing between wires adjusted until the wire element is resonant on the same frequency as the original tubular element. The principle is illustrated in Fig 18.

As a practical—although still hypothetical—example, let us take the longest element of the 100-ft, 20-element “Tau-tapered” array. This element in tubular form is 6.5 inches in diameter. The element is 2007.36 inches (167.28 ft) long. Isolated, it is resonant at 2.796 MHz, with a source impedance of $72.00 - j0.02 \Omega$. An equivalent #10-aluminum-wire element of the same length requires that the pair of wires be shorted at both their outer ends and at the feed point. Under these conditions, a spacing of 14 inches yields a resonant element at 2.796 MHz with an impedance of $70.53 + j0.08 \Omega$. There is a 0.02-dB deficit in gain owing

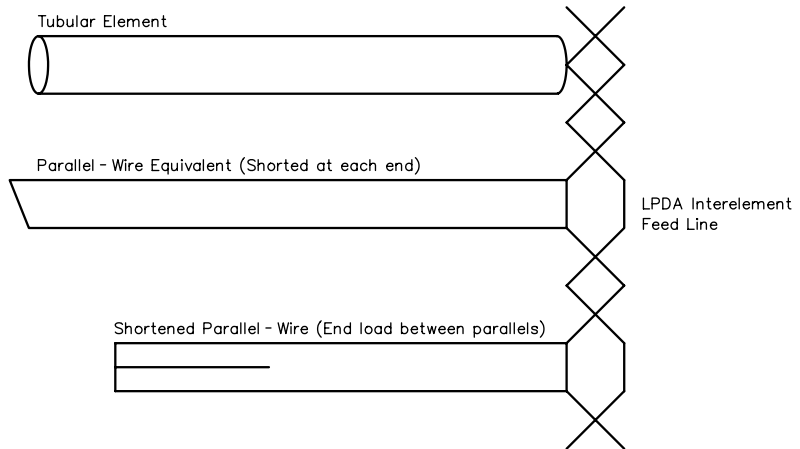

Fig 18—Evolution from tubular elements to equivalent wire elements to possible shortened-wire elements.

to the slightly higher loss of the wire element.

Now let us shorten the wire element to 1680 inches (140 ft) or 840 inches each side of center. If we run a wire from the center of the outer end shorting wire toward the feed point to a position 67.4 inches away from the feed point, we again achieve resonance at 2.796 MHz. The loading effect reduces the element impedance to $46.50 + j0.88 \Omega$, and the gain is further decreased 0.25 dB. The seven-inch spacing between wires is sufficient to prevent arcing between wires for any power level.

Whether the shortened element would yield acceptable performance at the lower end of the 3-30 MHz passband has not been determined with models. However, the technique represents one of the simplest methods of shortening elements and preserving much of the current distribution on the element’s center in an all-wire LPDA design.

A Final Question: Gain

The low gain of the LPDA models we have so far examined likely has two causes. First is the short boom length

used, which results in borderline values for Sigma, in the 0.03 region. Ideal values for Sigma result in wider-spaced elements on much longer booms.

A second cause for the low gain, especially as it tapers off below 9 MHz, lies in the use of thin elements. Programs like *LPCAD* calculate element lengths based on a length-to-diameter ratio of 125, whereas even in the “Tau-tapered” models, the ratio is about 300:1. In general, as frequency increases, there is no gain problem, since the effective region of activity can simply move rearward for any frequency relative to what the active region would be for an idealized design. For the lowest frequencies, the longest element sets the limit of how far back the active region can move.

However, gain at the lowest design frequency is not solely a function of the longest element. It is also a function of the number and arrangement of elements forward of the longest element. Whichever way one wishes to achieve more gain, there is no escaping the need for a longer boom. We shall examine some longer designs in [Part 2](#).

Antenna Model Descriptions

You can download this package from the ARRL Web site <http://www.arrl.org/files/qex/>. Look for LPDAPT1.ZIP.

60' 20-Element 3-30 MHz LPDA Frequency = 3 MHz.

Wire Loss: Aluminum Resistivity = 4E08 ohmm, Rel. Perm. = 1

WIRES						
Wire Conn.	End 1 (x,y,z : in)	Conn.	End 2 (x,y,z : in)	Dia(in)	Segs	
1	1003.7, 0.000,	0.000	1003.68, 0.000, 0.000	2.00E+00	105	
2	876.93, 98.500,	0.000	876.930, 98.500, 0.000	2.00E+00	87	
3	766.19,184.560,	0.000	766.190,184.560, 0.000	1.87E+00	75	
4	669.44,259.750,	0.000	669.440,259.750, 0.000	1.75E+00	69	
5	584.90,325.450,	0.000	584.900,325.450, 0.000	1.75E+00	57	
6	511.04,382.850,	0.000	511.040,382.850, 0.000	1.62E+00	49	
7	446.50,433.000,	0.000	446.500,433.000, 0.000	1.50E+00	43	
8	390.12,476.820,	0.000	390.120,476.820, 0.000	1.50E+00	39	
9	340.85,515.110,	0.000	340.850,515.110, 0.000	1.38E+00	37	
10	297.81,546.560,	0.000	297.810,546.560, 0.000	1.25E+00	35	
11	260.20,577.790,	0.000	260.200,577.790, 0.000	1.25E+00	33	
12	227.34,603.320,	0.000	227.340,603.320, 0.000	1.12E+00	31	
13	198.65,625.630,	0.000	198.650,625.630, 0.000	1.00E+00	29	
14	173.55,645.130,	0.000	173.550,645.130, 0.000	1.00E+00	27	
15	151.63,662.160,	0.000	151.630,662.160, 0.000	8.75E01	25	
16	132.49,677.040,	0.000	132.490,677.040, 0.000	7.50E01	23	
17	115.76,690.040,	0.000	115.760,690.040, 0.000	7.50E01	21	
18	101.14,701.400,	0.000	101.140,701.400, 0.000	7.50E01	19	
19	88.370,711.330,	0.000	88.370,711.330, 0.000	6.25E01	17	
20	77.210,720.000,	0.000	77.210,720.000, 0.000	5.00E01	15	

SOURCES						
Source	Wire Seg.	Wire #/Pct Actual	From End 1 (Specified)	Ampl. (V, A)	Phase (Deg.)	Type
1	8	20 / 50.00	(20 / 50.00)	1.000	0.000	V

TRANSMISSION LINES							
Line	Wire #/% Actual	From End 1 (Specified)	Wire #/% Actual	From End 1 (Specified)	Length	Z0 Ohms	Vel Fact Norm
1	1/50.0	(1/50.0)	2/50.0	(2/50.0)	Actual dist	150.0	1.00 R
2	2/50.0	(2/50.0)	3/50.0	(3/50.0)	Actual dist	150.0	1.00 R
3	3/50.0	(3/50.0)	4/50.0	(4/50.0)	Actual dist	150.0	1.00 R
4	4/50.0	(4/50.0)	5/50.0	(5/50.0)	Actual dist	150.0	1.00 R
5	5/50.0	(5/50.0)	6/50.0	(6/50.0)	Actual dist	150.0	1.00 R
6	6/50.0	(6/50.0)	7/50.0	(7/50.0)	Actual dist	150.0	1.00 R
7	7/50.0	(7/50.0)	8/50.0	(8/50.0)	Actual dist	150.0	1.00 R
8	8/50.0	(8/50.0)	9/50.0	(9/50.0)	Actual dist	150.0	1.00 R
9	9/50.0	(9/50.0)	10/50.0	(10/50.0)	Actual dist	150.0	1.00 R
10	10/50.0	(10/50.0)	11/50.0	(11/50.0)	Actual dist	150.0	1.00 R
11	11/50.0	(11/50.0)	12/50.0	(12/50.0)	Actual dist	150.0	1.00 R
12	12/50.0	(12/50.0)	13/50.0	(13/50.0)	Actual dist	150.0	1.00 R
13	13/50.0	(13/50.0)	14/50.0	(14/50.0)	Actual dist	150.0	1.00 R
14	14/50.0	(14/50.0)	15/50.0	(15/50.0)	Actual dist	150.0	1.00 R
15	15/50.0	(15/50.0)	16/50.0	(16/50.0)	Actual dist	150.0	1.00 R
16	16/50.0	(16/50.0)	17/50.0	(17/50.0)	Actual dist	150.0	1.00 R
17	17/50.0	(17/50.0)	18/50.0	(18/50.0)	Actual dist	150.0	1.00 R
18	18/50.0	(18/50.0)	19/50.0	(19/50.0)	Actual dist	150.0	1.00 R
19	19/50.0	(19/50.0)	20/50.0	(20/50.0)	Actual dist	150.0	1.00 R

Ground type is Free Space

100' 20-Element 3-30 MHz LPDA Frequency = 10 MHz.

Wire Loss: Aluminum Resistivity = 4E08 ohmm, Rel. Perm. = 1

WIRES						
Wire Conn.	End 1 (x,y,z : in)	Conn.	End 2 (x,y,z : in)	Dia(in)	Segs	
1	1003.7, 0.000,	0.000	1003.68, 0.000, 0.000	2.00E+00	105	
2	876.93,164.170,	0.000	876.930,164.170, 0.000	2.00E+00	87	
3	766.19,307.600,	0.000	766.190,307.600, 0.000	1.87E+00	75	
4	669.44,432.920,	0.000	669.440,432.920, 0.000	1.75E+00	69	
5	584.90,542.420,	0.000	584.900,542.420, 0.000	1.75E+00	57	
6	511.04,638.090,	0.000	511.040,638.090, 0.000	1.62E+00	49	
7	446.50,721.680,	0.000	446.500,721.680, 0.000	1.50E+00	43	
8	390.12,794.710,	0.000	390.120,794.710, 0.000	1.50E+00	39	
9	340.85,858.520,	0.000	340.850,858.520, 0.000	1.38E+00	37	
10	297.81,914.280,	0.000	297.810,914.280, 0.000	1.25E+00	35	
11	260.20,962.980,	0.000	260.200,962.980, 0.000	1.25E+00	33	
12	227.34,1005.54,	0.000	227.340,1005.54, 0.000	1.12E+00	31	
13	198.65,1042.72,	0.000	198.650,1042.72, 0.000	1.00E+00	29	
14	173.55,1075.21,	0.000	173.550,1075.21, 0.000	1.00E+00	27	
15	151.63,1103.60,	0.000	151.630,1103.60, 0.000	8.75E01	25	
16	132.49,1128.40,	0.000	132.490,1128.40, 0.000	7.50E01	23	
17	115.76,1150.07,	0.000	115.760,1150.07, 0.000	7.50E01	21	
18	101.14,1169.00,	0.000	101.140,1169.00, 0.000	7.50E01	19	
19	88.370,1185.55,	0.000	88.370,1185.55, 0.000	6.25E01	17	
20	77.210,1200.00,	0.000	77.210,1200.00, 0.000	5.00E01	15	

SOURCES						
Source	Wire Seg.	Wire #/Pct Actual	From End 1 (Specified)	Ampl.(V, A)	Phase(Deg.)	Type
1	8	20 / 50.00	(20 / 50.00)	1.000	0.000	V

TRANSMISSION LINES							
Line	Wire #/% Actual	From End 1 (Specified)	Wire #/% Actual	From End 1 (Specified)	Length	Z0 Ohms	Vel Rev/ Fact Norm
1	1/50.0	(1/50.0)	2/50.0	(2/50.0)	Actual dist	200.0	1.00 R
2	2/50.0	(2/50.0)	3/50.0	(3/50.0)	Actual dist	200.0	1.00 R
3	3/50.0	(3/50.0)	4/50.0	(4/50.0)	Actual dist	200.0	1.00 R
4	4/50.0	(4/50.0)	5/50.0	(5/50.0)	Actual dist	200.0	1.00 R
5	5/50.0	(5/50.0)	6/50.0	(6/50.0)	Actual dist	200.0	1.00 R
6	6/50.0	(6/50.0)	7/50.0	(7/50.0)	Actual dist	200.0	1.00 R
7	7/50.0	(7/50.0)	8/50.0	(8/50.0)	Actual dist	200.0	1.00 R
8	8/50.0	(8/50.0)	9/50.0	(9/50.0)	Actual dist	200.0	1.00 R
9	9/50.0	(9/50.0)	10/50.0	(10/50.0)	Actual dist	200.0	1.00 R
10	10/50.0	(10/50.0)	11/50.0	(11/50.0)	Actual dist	200.0	1.00 R
11	11/50.0	(11/50.0)	12/50.0	(12/50.0)	Actual dist	200.0	1.00 R
12	12/50.0	(12/50.0)	13/50.0	(13/50.0)	Actual dist	200.0	1.00 R
13	13/50.0	(13/50.0)	14/50.0	(14/50.0)	Actual dist	200.0	1.00 R
14	14/50.0	(14/50.0)	15/50.0	(15/50.0)	Actual dist	200.0	1.00 R
15	15/50.0	(15/50.0)	16/50.0	(16/50.0)	Actual dist	200.0	1.00 R
16	16/50.0	(16/50.0)	17/50.0	(17/50.0)	Actual dist	200.0	1.00 R
17	17/50.0	(17/50.0)	18/50.0	(18/50.0)	Actual dist	200.0	1.00 R
18	18/50.0	(18/50.0)	19/50.0	(19/50.0)	Actual dist	200.0	1.00 R
19	19/50.0	(19/50.0)	20/50.0	(20/50.0)	Actual dist	200.0	1.00 R
20	1/50.0	(1/50.0)	Short ckt	(Short ck)	90.000 in	200.0	1.00

Ground type is Free Space

100' 20-Element 3-30 MHz LPDA, "Tau-tapered" elements Frequency = 10 MHz.

Wire Loss: Aluminum Resistivity = 4E08 ohmm, Rel. Perm. = 1

WIRES							
Wire Conn.	End 1 (x,y,z : in)	Conn.	End 2 (x,y,z : in)	Dia(in)	Segs		
1	1003.7, 0.000,	0.000	1003.68, 0.000,	0.000	6.50E+00		
2	876.93,164.170,	0.000	876.930,164.170,	0.000	5.68E+00		
3	766.19,307.600,	0.000	766.190,307.600,	0.000	4.96E+00		
4	669.44,432.920,	0.000	669.440,432.920,	0.000	4.33E+00		
5	584.90,542.420,	0.000	584.900,542.420,	0.000	3.79E+00		
6	511.04,638.090,	0.000	511.040,638.090,	0.000	3.31E+00		
7	446.50,721.680,	0.000	446.500,721.680,	0.000	2.89E+00		
8	390.12,794.710,	0.000	390.120,794.710,	0.000	2.53E+00		
9	340.85,858.520,	0.000	340.850,858.520,	0.000	2.20E+00		
10	297.81,914.280,	0.000	297.810,914.280,	0.000	1.93E+00		
11	260.20,962.980,	0.000	260.200,962.980,	0.000	1.69E+00		
12	227.34,1005.54,	0.000	227.340,1005.54,	0.000	1.47E+00		
13	198.65,1042.72,	0.000	198.650,1042.72,	0.000	1.29E+00		
14	173.55,1075.21,	0.000	173.550,1075.21,	0.000	1.12E+00		
15	151.63,1103.60,	0.000	151.630,1103.60,	0.000	9.80E01		
16	132.49,1128.40,	0.000	132.490,1128.40,	0.000	8.60E01		
17	115.76,1150.07,	0.000	115.760,1150.07,	0.000	7.50E01		
18	101.14,1169.00,	0.000	101.140,1169.00,	0.000	6.60E01		
19	88.370,1185.55,	0.000	88.370,1185.55,	0.000	5.70E01		
20	77.210,1200.00,	0.000	77.210,1200.00,	0.000	5.00E01		

SOURCES						
Source	Wire Seg.	Wire #/Pct Actual	From End 1 (Specified)	Ampl.(V, A)	Phase(Deg.)	Type
1	8	20 / 50.00	(20 / 50.00)	1.000	0.000	V

TRANSMISSION LINES							
Line	Wire #/% Actual	From End 1 (Specified)	Wire #/% Actual	From End 1 (Specified)	Length	Z0 Ohms	Vel Rev/ Fact Norm
1	1/50.0	(1/50.0)	2/50.0	(2/50.0)	Actual dist	200.0	1.00 R
2	2/50.0	(2/50.0)	3/50.0	(3/50.0)	Actual dist	200.0	1.00 R
3	3/50.0	(3/50.0)	4/50.0	(4/50.0)	Actual dist	200.0	1.00 R
4	4/50.0	(4/50.0)	5/50.0	(5/50.0)	Actual dist	200.0	1.00 R
5	5/50.0	(5/50.0)	6/50.0	(6/50.0)	Actual dist	200.0	1.00 R
6	6/50.0	(6/50.0)	7/50.0	(7/50.0)	Actual dist	200.0	1.00 R
7	7/50.0	(7/50.0)	8/50.0	(8/50.0)	Actual dist	200.0	1.00 R
8	8/50.0	(8/50.0)	9/50.0	(9/50.0)	Actual dist	200.0	1.00 R
9	9/50.0	(9/50.0)	10/50.0	(10/50.0)	Actual dist	200.0	1.00 R
10	10/50.0	(10/50.0)	11/50.0	(11/50.0)	Actual dist	200.0	1.00 R
11	11/50.0	(11/50.0)	12/50.0	(12/50.0)	Actual dist	200.0	1.00 R
12	12/50.0	(12/50.0)	13/50.0	(13/50.0)	Actual dist	200.0	1.00 R
13	13/50.0	(13/50.0)	14/50.0	(14/50.0)	Actual dist	200.0	1.00 R
14	14/50.0	(14/50.0)	15/50.0	(15/50.0)	Actual dist	200.0	1.00 R
15	15/50.0	(15/50.0)	16/50.0	(16/50.0)	Actual dist	200.0	1.00 R
16	16/50.0	(16/50.0)	17/50.0	(17/50.0)	Actual dist	200.0	1.00 R
17	17/50.0	(17/50.0)	18/50.0	(18/50.0)	Actual dist	200.0	1.00 R
18	18/50.0	(18/50.0)	19/50.0	(19/50.0)	Actual dist	200.0	1.00 R
19	19/50.0	(19/50.0)	20/50.0	(20/50.0)	Actual dist	200.0	1.00 R
20	1/50.0	(1/50.0)	Short ckt	(Short ck)	90.000 in	200.0	1.00

Ground type is Free Space

Wire Loss: Aluminum Resistivity = 4E08 ohmm, Rel. Perm. = 1

WIRES						
Wire Conn.	End 1 (x,y,z : in)	Conn.	End 2 (x,y,z : in)	Dia(in)	Segs	
1	1003.7, 0.000,	0.000	1003.68, 0.000, 0.000	2.50E+00	107	
2	905.81,126.760,	0.000	905.810,126.760, 0.000	2.50E+00	97	
3	817.49,241.170,	0.000	817.490,241.170, 0.000	2.38E+00	87	
4	737.77,344.410,	0.000	737.770,344.410, 0.000	2.25E+00	79	
5	655.83,437.590,	0.000	655.830,437.590, 0.000	2.25E+00	71	
6	600.91,521.690,	0.000	600.910,521.690, 0.000	2.12E+00	65	
7	542.31,597.580,	0.000	542.310,597.580, 0.000	2.00E+00	57	
8	489.43,666.070,	0.000	489.430,666.070, 0.000	2.00E+00	53	
9	441.71,727.890,	0.000	441.710,727.890, 0.000	1.87E+00	47	
10	398.64,783.640,	0.000	398.640,783.640, 0.000	1.75E+00	43	
11	359.76,834.020,	0.000	359.760,834.020, 0.000	1.75E+00	39	
12	324.68,879.460,	0.000	324.680,879.460, 0.000	1.62E+00	35	
13	293.02,920.470,	0.000	293.020,920.470, 0.000	1.50E+00	31	
14	264.45,957.470,	0.000	264.450,957.470, 0.000	1.50E+00	29	
15	238.66,990.870,	0.000	238.660,990.870, 0.000	1.38E+00	25	
16	215.39,1021.01,	0.000	215.390,1021.01, 0.000	1.25E+00	23	
17	194.39,1048.22,	0.000	194.390,1048.22, 0.000	1.25E+00	21	
18	175.43,1072.77,	0.000	175.430,1072.77, 0.000	1.12E+00	19	
19	158.33,1094.93,	0.000	158.330,1094.93, 0.000	1.00E+00	17	
20	142.89,1114.93,	0.000	142.890,1114.93, 0.000	1.00E+00	15	
21	128.96,1132.97,	0.000	128.960,1132.97, 0.000	8.75E01	15	
22	116.38,1149.26,	0.000	116.380,1149.26, 0.000	7.50E01	13	
23	105.03,1163.96,	0.000	105.030,1163.96, 0.000	7.50E01	11	
24	94.790,1177.22,	0.000	94.790,1177.22, 0.000	6.25E01	11	
25	85.550,1189.20,	0.000	85.550,1189.20, 0.000	5.00E01	9	
26	77.210,1200.00,	0.000	77.210,1200.00, 0.000	5.00E01	9	

SOURCES						
Source	Wire Seg.	Wire #/Pct Actual	From End 1 (Specified)	Ampl.(V, A)	Phase(Deg.)	Type
1	5	26 / 50.00	(26 / 50.00)	1.000	0.000	V

TRANSMISSION LINES							
Line	Wire #/% Actual	From End 1 (Specified)	Wire #/% Actual	From End 1 (Specified)	Length	Z0 Ohms	Vel Rev/ Fact Norm
1	1/50.0	(1/50.0)	2/50.0	(2/50.0)	Actual dist	150.0	1.00 R
2	2/50.0	(2/50.0)	3/50.0	(3/50.0)	Actual dist	150.0	1.00 R
3	3/50.0	(3/50.0)	4/50.0	(4/50.0)	Actual dist	150.0	1.00 R
4	4/50.0	(4/50.0)	5/50.0	(5/50.0)	Actual dist	150.0	1.00 R
5	5/50.0	(5/50.0)	6/50.0	(6/50.0)	Actual dist	150.0	1.00 R
6	6/50.0	(6/50.0)	7/50.0	(7/50.0)	Actual dist	150.0	1.00 R
7	7/50.0	(7/50.0)	8/50.0	(8/50.0)	Actual dist	150.0	1.00 R
8	8/50.0	(8/50.0)	9/50.0	(9/50.0)	Actual dist	150.0	1.00 R
9	9/50.0	(9/50.0)	10/50.0	(10/50.0)	Actual dist	150.0	1.00 R
10	10/50.0	(10/50.0)	11/50.0	(11/50.0)	Actual dist	150.0	1.00 R
11	11/50.0	(11/50.0)	12/50.0	(12/50.0)	Actual dist	150.0	1.00 R
12	12/50.0	(12/50.0)	13/50.0	(13/50.0)	Actual dist	150.0	1.00 R
13	13/50.0	(13/50.0)	14/50.0	(14/50.0)	Actual dist	150.0	1.00 R
14	14/50.0	(14/50.0)	15/50.0	(15/50.0)	Actual dist	150.0	1.00 R
15	15/50.0	(15/50.0)	16/50.0	(16/50.0)	Actual dist	150.0	1.00 R
16	16/50.0	(16/50.0)	17/50.0	(17/50.0)	Actual dist	150.0	1.00 R
17	17/50.0	(17/50.0)	18/50.0	(18/50.0)	Actual dist	150.0	1.00 R
18	18/50.0	(18/50.0)	19/50.0	(19/50.0)	Actual dist	150.0	1.00 R
19	19/50.0	(19/50.0)	20/50.0	(20/50.0)	Actual dist	150.0	1.00 R
20	20/50.0	(20/50.0)	21/50.0	(21/50.0)	Actual dist	150.0	1.00 R
21	21/50.0	(21/50.0)	22/50.0	(22/50.0)	Actual dist	150.0	1.00 R
22	22/50.0	(22/50.0)	23/50.0	(23/50.0)	Actual dist	150.0	1.00 R
23	23/50.0	(23/50.0)	24/50.0	(24/50.0)	Actual dist	150.0	1.00 R
24	24/50.0	(24/50.0)	25/50.0	(25/50.0)	Actual dist	150.0	1.00 R
25	25/50.0	(25/50.0)	26/50.0	(26/50.0)	Actual dist	150.0	1.00 R
26	1/50.0	(1/50.0)	Short ckt	(Short ck)	90.000 in	150.0	1.00

Ground type is Free Space

100' 26-Element 3-30 MHz LPDA, "Tau-tapered" elements Frequency = 10 MHz.

Wire Loss: Aluminum Resistivity = 4E08 ohmm, Rel. Perm. = 1

WIRES						
Wire Conn.	End 1 (x,y,z : in)	Conn.	End 2 (x,y,z : in)	Dia(in)	Segs	
1	1003.7, 0.000,	0.000	1003.68, 0.000, 0.000	6.50E+00	107	
2	905.81,126.760,	0.000	905.810,126.760, 0.000	5.87E+00	97	
3	817.49,241.170,	0.000	817.490,241.170, 0.000	5.30E+00	87	
4	737.77,344.410,	0.000	737.770,344.410, 0.000	4.79E+00	79	
5	655.83,437.590,	0.000	655.830,437.590, 0.000	4.32E+00	71	
6	600.91,521.690,	0.000	600.910,521.690, 0.000	3.90E+00	65	
7	542.31,597.580,	0.000	542.310,597.580, 0.000	3.52E+00	57	
8	489.43,666.070,	0.000	489.430,666.070, 0.000	3.18E+00	53	
9	441.71,727.890,	0.000	441.710,727.890, 0.000	2.87E+00	47	
10	398.64,783.640,	0.000	398.640,783.640, 0.000	2.59E+00	43	
11	359.76,834.020,	0.000	359.760,834.020, 0.000	2.34E+00	39	
12	324.68,879.460,	0.000	324.680,879.460, 0.000	2.12E+00	35	
13	293.02,920.470,	0.000	293.020,920.470, 0.000	1.91E+00	31	
14	264.45,957.470,	0.000	264.450,957.470, 0.000	1.73E+00	29	
15	238.66,990.870,	0.000	238.660,990.870, 0.000	1.56E+00	25	
16	215.39,1021.01,	0.000	215.390,1021.01, 0.000	1.41E+00	23	
17	194.39,1048.22,	0.000	194.390,1048.22, 0.000	1.27E+00	21	
18	175.43,1072.77,	0.000	175.430,1072.77, 0.000	1.15E+00	19	
19	158.33,1094.93,	0.000	158.330,1094.93, 0.000	1.04E+00	17	
20	142.89,1114.93,	0.000	142.890,1114.93, 0.000	9.40E01	15	
21	128.96,1132.97,	0.000	128.960,1132.97, 0.000	8.40E01	15	
22	116.38,1149.26,	0.000	116.380,1149.26, 0.000	7.60E01	13	
23	105.03,1163.96,	0.000	105.030,1163.96, 0.000	6.90E01	11	
24	94.790,1177.22,	0.000	94.790,1177.22, 0.000	6.20E01	11	
25	85.550,1189.20,	0.000	85.550,1189.20, 0.000	5.60E01	9	
26	77.210,1200.00,	0.000	77.210,1200.00, 0.000	5.00E01	9	

SOURCES						
Source	Wire Seg.	Wire #/Pct Actual	From End 1 (Specified)	Ampl.(V, A)	Phase(Deg.)	Type
1	5	26 / 50.00	(26 / 50.00)	1.000	0.000	V

TRANSMISSION LINES							
Line	Wire #/% Actual	From End 1 (Specified)	Wire #/% Actual	From End 1 (Specified)	Length	Z0 Ohms	Vel Rev/ Fact Norm
1	1/50.0	(1/50.0)	2/50.0	(2/50.0)	Actual dist	150.0	1.00 R
2	2/50.0	(2/50.0)	3/50.0	(3/50.0)	Actual dist	150.0	1.00 R
3	3/50.0	(3/50.0)	4/50.0	(4/50.0)	Actual dist	150.0	1.00 R
4	4/50.0	(4/50.0)	5/50.0	(5/50.0)	Actual dist	150.0	1.00 R
5	5/50.0	(5/50.0)	6/50.0	(6/50.0)	Actual dist	150.0	1.00 R
6	6/50.0	(6/50.0)	7/50.0	(7/50.0)	Actual dist	150.0	1.00 R
7	7/50.0	(7/50.0)	8/50.0	(8/50.0)	Actual dist	150.0	1.00 R
8	8/50.0	(8/50.0)	9/50.0	(9/50.0)	Actual dist	150.0	1.00 R
9	9/50.0	(9/50.0)	10/50.0	(10/50.0)	Actual dist	150.0	1.00 R
10	10/50.0	(10/50.0)	11/50.0	(11/50.0)	Actual dist	150.0	1.00 R
11	11/50.0	(11/50.0)	12/50.0	(12/50.0)	Actual dist	150.0	1.00 R
12	12/50.0	(12/50.0)	13/50.0	(13/50.0)	Actual dist	150.0	1.00 R
13	13/50.0	(13/50.0)	14/50.0	(14/50.0)	Actual dist	150.0	1.00 R
14	14/50.0	(14/50.0)	15/50.0	(15/50.0)	Actual dist	150.0	1.00 R
15	15/50.0	(15/50.0)	16/50.0	(16/50.0)	Actual dist	150.0	1.00 R
16	16/50.0	(16/50.0)	17/50.0	(17/50.0)	Actual dist	150.0	1.00 R
17	17/50.0	(17/50.0)	18/50.0	(18/50.0)	Actual dist	150.0	1.00 R
18	18/50.0	(18/50.0)	19/50.0	(19/50.0)	Actual dist	150.0	1.00 R
19	19/50.0	(19/50.0)	20/50.0	(20/50.0)	Actual dist	150.0	1.00 R
20	20/50.0	(20/50.0)	21/50.0	(21/50.0)	Actual dist	150.0	1.00 R
21	21/50.0	(21/50.0)	22/50.0	(22/50.0)	Actual dist	150.0	1.00 R
22	22/50.0	(22/50.0)	23/50.0	(23/50.0)	Actual dist	150.0	1.00 R
23	23/50.0	(23/50.0)	24/50.0	(24/50.0)	Actual dist	150.0	1.00 R
24	24/50.0	(24/50.0)	25/50.0	(25/50.0)	Actual dist	150.0	1.00 R
25	25/50.0	(25/50.0)	26/50.0	(26/50.0)	Actual dist	150.0	1.00 R
26	1/50.0	(1/50.0)	Short ckt	(Short ck)	90.000 in	150.0	1.00

Ground type is Free Space

